

NATIONAL[™]

Refrigerant Reference Guide



National Refrigerants, Inc.

2016

Sixth Edition

2016



TABLE OF CONTENTS

SECTION I — REFRIGERANTS: TECHNICAL DATA

4	Product Part Numbers
7	Refrigerant Property Summary
9	Application Summary
11	Product Data Summary and Thermodynamic Tables
12	R-11 and R-12
15	R-13
17	R-22
19	R-23
21	R-32
23	R-123 and R-124
26	R-134a
28	R-401A and R-401B
31	R-402A and R-402B
34	R-403B
36	R-404A
38	R-407A
40	R-407C
42	R-408A
44	R-409A
46	R-410A
48	R-414B
50	R-417C
52	R-422C
54	R-422B and R-422D
57	R-500 and R-502
60	R-503
62	R-507
64	R-508B
66	Ultra-Low Temperature Refrigeration
68	AHRI Chemical Names and Color Codes

SECTION II — RETROFITS AND CONVERSIONS



70	Introduction to Retrofitting: Blends Tutorial
71	Fractionation
79	Temperature Glide
87	Application Property Match
90	Retrofitting Guidelines and Procedures
90	Checklist and Data Sheet
92	R-22 Alternative Retrofit Guidelines
94	General Retrofit Procedures
96	Sizing Thermostatic Expansion Devices (TXV)



SECTION III — REFRIGERANT MANAGEMENT SERVICES

- 100 Analytical Testing Service
- 101 Request for Refrigerant Analysis
- 103 Request for Oil Analysis
- 105 Recovery Cylinder Hydro-Test & Refurbish Program
- 106 Refrigerant Recovery Containers
- 107 Instructions for Participating in NRI's Refrigerant Reclamation Program
- 109 EZ One-Shot™ Recovery Cylinder
- 111 Refrigerant Banking Program
- 112 Guidelines for Maximum Shipping Weights for Recovered Refrigerant Containers

SECTION IV — ADDITIONAL TECHNICAL LITERATURE

- 114 Glossary of Terms
- 118  Lubricant Cross Reference Guide
- 122  Lubricants
- 126  Propylene Glycol

SECTION V — REGULATORY & LEGISLATIVE ISSUES

- 130 Complying with Section 608 Regulations
- 138 The Refrigerant Sales Restriction
- 141 Leak Repair
- 143 Changing Refrigerant Oil
- 144 Overlap between Section 608 and Section 609
- 146 EPA HCFC Allocation and Pre-charged Equipment Rules



REFRIGERANTS: TECHNICAL DATA

PG: 4-10 NRI PRODUCTS

- 4 NRI Product Part Numbers
- 7 Refrigerant Property Summary
- 9 Application Summary

PG: 11-64 PRODUCT DATA SUMMARY & THERMODYNAMIC TABLES

- 12 R-11 and R-12
- 15 R-13
- 17 R-22
- 19 R-23
- 21 R-32
- 23 R-123 and R-124
- 26 R-134a
- 28 R-401A and R-401B
- 31 R-402A and R-402B
- 34 R-403B
- 36 R-404A
- 38 R-407A
- 40 R-407C
- 42 R-408A
- 44 R-409A
- 46 R-410A
- 48 R-414B
- 50 R-417C
- 52 R-422C
- 54 R-422B and R-422D
- 57 R-500 and R-502
- 60 R-503
- 62 R-507
- 64 R-508B

PG: 66 ULTRA-LOW TEMPERATURE REFRIGERATION

PG: 68 AHRI CHEMICAL NAMES & COLOR CODES



Refrigerants

[AVAILABLE IN SIZES]

REFRIGERANTS	PART NO.	TYPE	SIZE
R-11	100R11	Drum	100 lb.
R-12	30R12	Cylinder	30 lb.
R-13	5R13	Cylinder	5 lb.
R-13B1	5R13B1	Cylinder	5 lb.
R-22	30R22	Cylinder	30 lb.
	50R22	Cylinder	50 lb.
	125R22	Cylinder	125 lb.*
	1000R22	Cylinder	1,000 lb.*
R-23	1750R22	Cylinder	1,750 lb.*
	5R23	Cylinder	5 lb.
	9R23	Cylinder	9 lb.*
	20R23	Cylinder	20 lb.*
R-113	70R23	Cylinder	70 lb.*
	100R113	Drum	100 lb.
R-114	30R114	Cylinder	30 lb.
R-123	100R123	Drum	100 lb.
	200R123	Drum	200 lb.
	650R123	Drum	650 lb.
R-124	30R124	Cylinder	30 lb.
	145R124	Cylinder	145 lb.*
R-134a	012R134a	Can	12 oz.
	30R134a	Cylinder	30 lb.
	A30R134a	Cylinder Automotive Valve	30 lb.
	125R134a	Cylinder	125 lb.*
	1000R134a	Cylinder	1,000 lb.*
R-401A	1750R134a	Cylinder	1,750 lb.*
	30R401A	Cylinder	30 lb.
R-401B	125R401A	Cylinder	125 lb.*
	30R401B	Cylinder	30 lb.
	125R401B	Cylinder	125 lb.*

[AVAILABLE IN SIZES]

REFRIGERANTS	PART NO.	TYPE	SIZE
R-402A	27R402A	Cylinder	27 lb.
	110R402A	Cylinder	110 lb.*
R-402B	13R402B	Cylinder	13 lb.
R-403B	25R403B	Cylinder	25 lb.
R-404A	24R404A	Cylinder	24 lb.
	100R404A	Cylinder	100 lb.*
	800R404A	Cylinder	800 lb.*
R-407A	1300R404A	Cylinder	1,300 lb.*
	25R407A	Cylinder	25 lb.
	100R407A	Cylinder	100 lb.*
	925R407A	Cylinder	925 lb.*
R-407C	1550R407A	Cylinder	1,550 lb.*
	25R407C	Cylinder	25 lb.
	115R407C	Cylinder	115 lb.*
	925R407C	Cylinder	925 lb.*
R-408A	1550R407C	Cylinder	1,550 lb.*
	24R408A	Cylinder	24 lb.
	100R408A	Cylinder	100 lb.*
R-409A	30R409A	Cylinder	30 lb.
	125R409A	Cylinder	125 lb.*
R-410A	25R410A	Cylinder	25 lb.
	100R410A	Cylinder	100 lb.*
	850R410A	Cylinder	850 lb.*
	1450R410A	Cylinder	1,450 lb.*
R-414B	25R414B	Cylinder	25 lb.
R-417C	25R417C	Cylinder	25 lb.
R-422B	25R422B	Cylinder	25 lb.
	110R422B	Cylinder	110 lb.*
R-422C	24R422C	Cylinder	24 lb.
	100R422C	Cylinder	100 lb.*
R-422D	25R422D	Cylinder	25 lb.
	110R422D	Cylinder	110 lb.*
R-500	30R500	Cylinder	30 lb.
	125R500	Cylinder	125 lb.*
R-502	30R502	Cylinder	30 lb.
	125R502	Cylinder	125 lb.*
R-503	5R503	Cylinder	5 lb.
	9R503	Cylinder	9 lb.*
	20R503	Cylinder	20 lb.*
	80R503	Cylinder	80 lb.*

* RETURNABLE / DEPOSIT



Refrigerants, Analytical Testing, Lubricants

[AVAILABLE IN SIZES]

REFRIGERANTS	PART NO.	TYPE	SIZE
R-507	25R507	Cylinder	25 lb.
	100R507	Cylinder	100 lb.*
	800R507	Cylinder	800 lb.*
	1400R507	Cylinder	1,400 lb.*
R-508B	5R508B	Cylinder	5 lb.
	10R508B	Cylinder	10 lb.*
	20R508B	Cylinder	20 lb.*
	70R508B	Cylinder	70 lb.*
R-170 (Ethane)	3R170	Cylinder	3 lb.
	004R170	Cylinder	4 oz.
R-1150 (Ethylene)	004R1150	Cylinder	4 oz.
R-600 (Butane)	016R600	Cylinder	16 oz.
R-600a (Isobutane)	016R600a	Cylinder	16 oz.
R-290 (Propane)	014R290	Cylinder	14 oz.
PENTANE (Liquid)	016RPENTANE	Metal Can	16 oz.

[AVAILABLE IN SIZES]

 MINERAL OIL	PART NO.	VISCOSITY	SIZE
NL 150	1501G	150 SUS / 32 ISO	1 Gallon
	1505G		5 Gallon
	15055G		55 Gallon
NL 300	3001G	300 SUS / 68 ISO	1 Gallon
	3005G		5 Gallon
	30055G		55 Gallon
NL 500	5001G	500 SUS / 100 ISO	1 Gallon
	5005G		5 Gallon
	50055G		55 Gallon
NL WF32	WF32	150 SUS / 32 ISO	1 Gallon
	WF325G		5 Gallon
	WF3255G		55 Gallon
NL WF68	1TD	300 SUS / 68 ISO	1 Gallon
	5TD		5 Gallon
	55TD		55 Gallon

[AVAILABLE IN SIZES]

 ALKYL BENZENE OIL	PART NO.	VISCOSITY	SIZE
NL AKB150	150AKB1G	150 SUS / 32 ISO	1 Gallon
	150AKB5G		5 Gallon
	150AKB55G		55 Gallon
NL AKB200R	200AKB1G	200 SUS / 46 ISO	1 Gallon
	200AKB5G		5 Gallon
	200AKB55G		55 Gallon
NL AKB300	300AKB1G	300 SUS / 68 ISO	1 Gallon
	300AKB5G		5 Gallon
	300AKB55G		55 Gallon
NL AKB500	AKB500E1G	500 SUS / 100 ISO	1 Gallon
	AKB500E5G		5 Gallon
	AKB500E55G		55 Gallon

 POLYOLESTER

NL PE32	PE321P	150 SUS / 32 ISO	1 Pint
	PE321Q		1 Quart
	PE321G		1 Gallon
NL PE68	PE681P	300 SUS / 68 ISO	1 Pint
	PE681Q		1 Quart
	PE681G		1 Gallon

 VACUUM PUMP OIL

NL VPO	VPO1P	200 SUS / 46 ISO	1 Pint
	VPO1Q		1 Quart
	VPO1G		1 Gallon

ANALYTICAL TESTING

	DESCRIPTION
NRIHPN	High Pressure Liquid Refrigerant Test Kit
NRILP	Low Pressure Liquid Refrigerant Test Kit
NRINCN	Non-Condensable Vapor Refrigerant Test Kit
NRIOA	Oil Analysis Test Kit
NRIHALON	Halon Analysis

* RETURNABLE / DEPOSIT



Solest[®], Chemicals, Recovery Containers, Cylinder Refurbishing

[AVAILABLE IN SIZES]

SOLEST	PART NO.	VISCOSITY	SIZE**
Solest LT32	SolestLT321G	150 SUS / 32 ISO	1 Gallon
Solest 46	Solest461G	200 SUS / 46 ISO	1 Gallon
Solest 68	Solest681G	300 SUS / 68 ISO	1 Gallon
Solest 100	Solest1001G	500 SUS / 100 ISO	1 Gallon
Solest 120	Solest1201G	600 SUS / 120 ISO	1 Gallon
Solest 150	Solest1501G	700 SUS / 150 ISO	1 Gallon
CP4214-150	CP4214-1505G	700 SUS / 150 ISO	5 Gallon
Solest 170	Solest1701G	800 SUS / 170 ISO	1 Gallon
Solest 220	Solest2201G	1000 SUS/220 ISO	1 Gallon
CP4214-320	CP4214-3201G	1500 SUS / 320 ISO	1 Gallon
Solest 220	Solest3701G	1700 SUS / 370 ISO	1 Gallon

**Also available in 5 Gallon and 55 Gallon containers

[AVAILABLE IN SIZES]

CHEMICALS	PART NO.	SIZE
Propylene Glycol		
96% Inhibited Propylene Glycol (No dye)	5PG96	5 Gallon
	55PG96	55 Gallon
70% Inhibited Propylene Glycol (blue dye)	1PG70	1 Gallon
	5PG70	5 Gallon
	55PG70	55 Gallon
40% Inhibited Propylene Glycol (blue dye)	5PG40	5 Gallon
	55PG40	55 Gallon
35% Inhibited Propylene Glycol (blue dye)	55PG35D	55 Gallon
99.9% Uninhibited Propylene Glycol (No dye)	PROPYL55G	55 Gallon

[AVAILABLE IN SIZES]

RECOVERY CONTAINERS	PART NO.	SIZE
EZ One Shot	DC30	30 lb.
Recovery Cylinder	100RC30	30 lb.
	100RC40	40 lb.
	100RC50	50 lb.
Recovery Cylinder with Float	125RC50F	50 lb.
Recovery Cylinder Rated 400 PSI	125RC50HP	50 lb.
Recovery Cylinder	200RC125	125 lb.
	1500RC1000	1,000 lb.
	4500RC2000	2,000 lb.
Recovery Cylinder Very High Pressure	130RC9	9 lb.
	150RC23	23 lb.
	200RC80	80 lb.
Recovery Drums	C100DRUM	100 lb.
	C200DRUM	200 lb.
	C650DRUM	650 lb.

CYLINDER REFURBISHING

Disposal of Empty Non-Refillable	CYLDISP	Cylinder
	DRUMDISP	Drum
Hydrostatic Testing	HST	30 /40 /50 lb. Cylinder
	125HST	125 lb. Cylinder
	240HST	240 lb. Cylinder
	1/2TONHST	1/2 Ton Cylinder
	TONHST	1 Ton Cylinder
Refurbishing & Hydrostatic Testing	HSTR	30 /40 /50 lb. Cylinder
	125HSTR	125 lb. Cylinder
	240HSTR	240 lb. Cylinder
	1/2TONHSTR	1/2 Ton Cylinder
	TONHSTR	1 Ton Cylinder



Refrigerant Property Summary

	COMPONENTS (Weight %)	TYPE	TEMP. GLIDE (°F)	LUBRICANTS	COMMENTS
R-22	100%	HCFC	0	Mineral Oil or Alkylbenzene	Refrigeration systems, commercial refrigeration, air conditioning, chillers.
R-23	100%	HFC	0	Polyolester	Very low temperature refrigeration. Properties similar to R-13; can also retrofit R-503.
R-123	100%	HCFC	0	Mineral Oil or Alkylbenzene	Low pressure centrifugal chillers. Can retrofit R-11 equipment with modifications.
R-124	100%	HCFC	0	Mineral Oil or Alkylbenzene	High ambient air conditioning. Can retrofit R-114 equipment with modifications.
R-134a	100%	HFC	0	Polyolester	Medium temperature refrigeration, chillers, automotive A/C. Can retrofit R-12 and R-500 equipment.
R-401A	22/152a/124 (53/13/34)	HCFC Blend	8	Alkylbenzene or MO/AB Mix	Low/medium temperature refrigeration. Can retrofit R-12 and R-500 equipment.
R-401B	22/152a/124 (61/11/28)	HCFC Blend	8	Alkylbenzene or MO/AB Mix	Low/medium temperature refrigeration. Can retrofit R-12 and R-500 equipment.
R-402A	125/290/22 (60/2/38)	HCFC Blend	2.5	Alkylbenzene or MO/AB Mix	Low/medium temperature refrigeration. Can retrofit R-502 equipment.
R-402B	125/290/22 (38/2/60)	HCFC Blend	2.5	Alkylbenzene or MO/AB Mix	Ice machines. Can retrofit R-502 equipment.
R-403B	290/22/218 (5/56/39)	HCFC Blend	2	Mineral Oil or Alkylbenzene	Has been used successfully to retrofit R-13B1-type equipment, but has slightly different operating conditions.
R-404A	125/143a/134a (44/52/4)	HFC Blend	1.5	Polyolester	Low/medium temperature refrigeration. Can retrofit R-502 or R-22 equipment with modifications.
R-407A	32/125/134a (20/40/40)	HFC Blend	10	Polyolester or POE/MO Mix	Low/medium temperature refrigeration. Can retrofit R-22 equipment.
R-407C	32/125/134a (23/25/52)	HFC Blend	10	Polyolester or POE/MO Mix	Low/medium temperature refrigeration, air conditioning. Can retrofit R-22 equipment.
R-408A	125/143a/22 (7/46/47)	HCFC Blend	1	Mineral Oil or Alkylbenzene	Low/medium temperature refrigeration. Can retrofit R-502 equipment.
R-409A	22/124/142b (60/25/15)	HCFC Blend	13	Mineral Oil or Alkylbenzene	Low/medium temperature refrigeration, some A/C. Can retrofit R-12 or R-500 equipment.
R-410A	32/125 (50/50)	HFC Blend	0.2	Polyolester	New residential A/C systems. Not for retrofitting.
R-414B	22/124/600a/142b (50/39/1.5/9.5)	HCFC Blend	13	Mineral Oil or Alkylbenzene	Low/medium temperature refrigeration, some A/C, automotive A/C. Can retrofit R-12 equipment.



Property Summary

	COMPONENTS (Weight %)	TYPE	TEMP. GLIDE (° F)	LUBRICANTS	COMMENTS
R-417C	125 / 134a / 600 (19.5/78.8/1.7)	HFC Blend	6	Mineral Oil, Alkylbenzene, or Polyolester	Low/medium temperature refrigeration, retrofit blend for R-12 applications. Can also replace HCFC-based blends
R-422B	125/134a/600a (55/42/3)	HFC Blend	5	Mineral Oil, Alkylbenzene or Polyolester	Medium temperature refrigeration, air conditioning. Can retrofit R-22 equipment.
R-422C	125/134a/600a (82/15/3)	HFC Blend	5	Mineral Oil, Alkylbenzene or Polyolester	Low/medium temperature refrigeration. Can retrofit R-502 and R-22 equipment, with modifications.
R-422D	125/134a/600a (65.1/13.5/3.4)	HFC Blend	5	Mineral Oil, Alkylbenzene or Polyolester	Low/medium temperature refrigeration. Can retrofit R-22 equipment.
R-507	125/143a (50/50)	HFC Blend	0	Polyolester	Low/medium temperature refrigeration. Can retrofit R-502 or R-22 equipment with modifications.
R-508B	23/116 (46/54)	HFC Blend	0	Polyolester	Very low temperature refrigeration. Can retrofit R-13 or R-503 equipment.



Application Summary

ASHRAE NO.	COMPONENTS (Weight %)	CHARGING (% ORIGINAL)	APPLICATION COMMENTS
------------	--------------------------	--------------------------	----------------------

Low-Medium Temperature Refrigeration (R-502 type)

R-402A	125/290/22 (60/2/38)	95 -100%	<p>Overall Concerns: Discharge temperature is important — can't tolerate large increase. Higher discharge pressure can affect controls. If oil return is not already a problem with R-502, the blends will not necessarily make things worse. HFC blends will need POE. Most of the blends have very low glide.</p> <p>Retrofit Recommendations (in order of preference based on performance/ease of use): R-408A Closest match to R-502 properties and performance. Slightly higher discharge temperature R-402A Higher discharge pressure, lower discharge temperature than R-408A R-402B Similar discharge pressure, higher discharge temperature. Good for ice machines. *R-408A, R-402A and R-402B might have problems with oil circulation and will benefit from at least a partial change to alkylbenzene. They are also HCFC-based and are subject to leak repair regulations.</p> <p>R-422C HFC-based. Similar in pressure/temperature to R-502, but will show some loss in capacity. Hydrocarbon components in the blend will promote mineral oil circulation in some systems. Addition of POE may be required in larger systems for proper oil return.</p> <p>Options in New Equipment R-407A Being used in supermarkets as a lower GWP option. R-404A & R-507 Off the shelf equipment (standard design). These two are interchangeable with each other in new equipment.</p>
R-402B	125/290/22 (38/2/60)	95 -100%	
R-404A	125/143a/134a (44/52/4)	85 - 90%	
R-408A	125/143a/22 (7/46/47)	85 - 90%	
R-422C	125/134a/600a (82/15/3)	95 -100%	
R-507	125/143a (50/50)	85 - 90%	

Low-Medium Temperature Refrigeration (R-22 type)

R-404A	125/143a/134a (44/52/4)	85 - 90%	<p>Overall Concerns: Capacity match to R-22 is important in capacity-critical applications. Cold storage applications can tolerate a loss of capacity traded off for longer run times. TXV operation and distributor capacity should be close to R-22 to avoid costly component changes. All retrofit blends will operate at lower discharge temperatures than R-22.</p> <p>Retrofit Recommendations (in order of preference based on performance/ease of use): R-407A Similar capacity and TXV/distributor/pressure drop performance. R-407C Slightly lower capacity, similar TXV/distributor/pressure drop performance. R-407A and R-407C will require a change from mineral oil to POE for proper oil circulation. Partial POE replacement of mineral should work in most systems.</p> <p>R-422D Lower capacity, change in TXV/distributor/pressure drop performance. R-422B Significant drop in capacity at lower temperatures, change in TXV/distributor/pressure drop. R-422C Higher capacity, TXV change. Similar to R-404A. All R-422 blends contain a hydrocarbon that will promote mineral oil circulation in some systems. Addition of POE may be required in larger systems for proper oil return.</p> <p>Options in New Equipment R-407A Being used in supermarkets as a lower GWP option. R-404A & R-507 Off the shelf equipment (standard design). These two are interchangeable with each other in new equipment.</p>
R-407A	32/125/134a (20/40/40)	95 -100%	
R-407C	32/125/134a (23/25/52)	95 -100%	
R-422B	125/134a/600a (55/42/3)	95 -100%	
R-422C	125/134a/600a (82/15/3)	95 -100%	
R-422D	125/134a/600a (65.1/31.5/3.4)	95 -100%	
R-507	125/143a (50/50)	85 - 90%	



Application Summary

ASHRAE NO.	COMPONENTS (Weight %)	CHARGING (% ORIGINAL)	APPLICATION COMMENTS
------------	--------------------------	--------------------------	----------------------

Low-Medium Temperature Refrigeration (R-12 type)

R-134a	100%	90%	<p>Overall Concerns: Match R-12 evaporator conditions (slightly higher discharge pressures OK). Oil return must be addressed. Temperature glide not a problem in most applications.</p> <p>Retrofit Recommendations (in order of preference based on performance/ease of use):</p> <p>R-409A Better at lower temperatures, maintains performance, higher discharge temperature and pressure.</p> <p>R-414B Better at warmer temperatures, lower discharge temperature than R-409A.</p> <p>R-401A Good overall performance, need AB oil below 30°F coil temperatures.</p> <p>R-401B Better at lower temperatures, needs AB oil to replace 50% mineral oil.</p> <p>R-417C HFC-based retrofit blend for HCFC blends</p>
R-401A	22/152a/124 (53/13/34)	80 - 85%	
R-401B	22/152a/124 (61/11/28)	80 - 85%	
R-409A	22/124/142b (60/25/15)	80 - 85%	
R-417C	125/134a/600 (19.5/78.8/1.7)	90%	

Medium-High Temperature Refrigeration (R-12 type), Automotive Air Conditioning

R-414B	22/124/600a/142b (50/39/1.5/9.5)	80-85%	<p>Overall Concerns: At higher evaporator temperatures, blends that contain R-22 will cause higher discharge temperatures. R-414B contains less R-22 and than the other R-12 alternative blends. R-414B will produce lower discharge temperatures, but they will also lose some capacity compared to the other R-12 retrofit products listed above.</p> <p>Retrofit Recommendations (in order of preference based on performance/ease of use):</p> <p>R-414B Only product that is approved for automotive A/C retrofit.</p> <p>R-401A, R-401B, R-409A For R-12 or R-500 air conditioning (direct expansion systems).</p>
--------	-------------------------------------	--------	--

Air Conditioning (R-22 type)

R-407C	32/125/134a (23/25/52)	95 -100%	<p>Overall Concerns: Keep component changes to a minimum (similar TXV or orifice size, minimize pressure drop), maintain capacity unless the system is oversized enough to handle a drop in capacity.</p> <p>Retrofit Recommendations (in order of preference based on performance/ease of use):</p> <p>R-407C Lowest GWP, similar capacity and component operation (TXV/orifice). R-422B or R-422D</p> <p>Slight drop in capacity, possible change of components based on pressure drop. Hydrocarbon components in the blends will promote mineral oil circulation in some systems. Addition of POE may be required in larger systems for proper oil return.</p> <p>Higher pressure and capacity exclude R-410A from being used as a retrofit blend. New equipment is designed around R-410A.</p>
R-410A	32/125 (50/50)	New Equipment Only	
R-422B	125/134a/600a (55/42/3)	90 - 95%	
R-422D	125/134a/600a (65.1/31.5/3.4)	90 - 95%	

High Ambient and Centrifugal Chillers

R-124	100%	N/A	Existing R-114 high ambient A/C systems can be modified to use R-124. New systems are available with R-134a. Centrifugal chillers require major equipment upgrades to retrofit to another refrigerant. Chiller manufacturers will need to be consulted for such jobs.
R-123	100%	N/A	

Very Low Temperature and Cascade Refrigeration (R-13 and R-503 type)

R-23	100%	95%	R-13 systems can be retrofitted to R-23 or R-508B. R-23 will have similar run-time properties to R-13 but there will be higher discharge temperatures. R-503 systems should use R-508B R-403B has been successfully used in R-13B1 systems but the evaporator will likely run under vacuum conditions.
R-508B	23/116 (46/54)	R-13: 105-110% R-503: 90-95%	
R-403B	290/22/218 (5/56/39)	70 - 75%	



Product Data Summary and Thermodynamic Tables



R-11 and R-12

R-11

Composition: 100% trichlorofluoromethane (CCl₃F)

Application: Large low pressure centrifugal chillers

Performance: Industry standard choice until 1990's

Lubricant: Compatible with mineral oil

Retrofitting:

- R-123 is being successfully used to retrofit R-11 chillers
- Retrofit jobs are usually done in cooperation with equipment manufacturers

R-12

Composition: 100% dichlorodifluoromethane (CCl₂F₂)

Application: Large centrifugal chillers, open drive AC, process cooling, high-medium-low temperature refrigeration (large and small systems)

Performance: Industry standard choice until 1990's

Lubricant: Compatible with mineral oil

Retrofitting:

- Consult the comments on Pages 9 and 10
See Section II, pages 92-98 for detailed discussion

[PRESSURE-TEMP CHART]

R-11 psig	TEMP. (°F)	R-12 psig
	-40	11.0"
	-35	8.4"
	-30	5.5"
	-25	2.3"
27.0"	-20	0.6
26.5"	-15	2.4
26.0"	-10	4.5
25.4"	-5	6.7
24.7"	0	9.2
23.9"	5	11.8
23.1"	10	14.6
22.1"	15	17.7
21.1"	20	21.0
19.9"	25	24.6
18.6"	30	28.5
17.2"	35	32.6
15.6"	40	37.0
13.9"	45	41.7
12.0"	50	46.7
10.0"	55	52.0
7.8"	60	57.7
5.4"	65	63.8
2.8"	70	70.2
0.0	75	77.0
1.5	80	84.2
3.2	85	91.8
4.9	90	99.8
6.8	95	108
8.8	100	117
10.9	105	127
13.2	110	136
15.6	115	147
18.2	120	158
21.0	125	169
24.0	130	181
27.1	135	194
30.4	140	207
34.0	145	220
37.7	150	234

[PHYSICAL PROPERTIES OF REFRIGERANTS]

	National R-11	National R-12
Environmental Classification	CFC	CFC
Molecular Weight	137.4	120.9
Boiling Point (1atm, °F)	74.7	-21.6
Critical Pressure (psia)	639.3	600
Critical Temperature (°F)	388	233.5
Critical Density (lb./ft ³)	34.6	35.3
Liquid Density (70°F, lb./ft ³)	92.73	82.96
Vapor Density (bp, lb./ft ³)	0.365	0.393
Heat of Vaporization (bp, BTU/lb.)	77.9	71.2
Specific Heat Liquid (70°F, BTU/lb.°F)	0.2093	0.2324
Specific Heat Vapor (1atm, 70°F, BTU/lb.°F)	0.1444 (sat)	0.1455
Ozone Depletion Potential (CFC 11 = 1.0)	1.0	1.0
Global Warming Potential (CO ₂ = 1.0)	4750	10910
ASHRAE Standard 34 Safety Rating	A1	A1

[AVAILABLE IN SIZES]

REFRIGERANT	Type	Size
R-11	Drum	100 lb.
R-12	Cylinder	30 lb.



Thermodynamic Properties of R-11

TEMP. (°F)	Pressure Liquid (psia)	Density Liquid (lb/ft ³)	Density Vapor (lb/ft ³)	Enthalpy Liquid (Btu/lb)	Enthalpy Vapor (Btu/lb)	Entropy Liquid (Btu/R-lb)	Entropy Vapor (Btu/R-lb)
30	5.6	95.93	0.1481	14.14	95.94	0.03112	0.1982
35	6.3	95.54	0.1654	15.16	96.56	0.03321	0.1977
40	7.0	95.14	0.1842	16.19	97.17	0.03528	0.1973
45	7.9	94.75	0.2047	17.23	97.79	0.03733	0.1970
50	8.8	94.35	0.2269	18.26	98.41	0.03937	0.1966
55	9.8	93.95	0.2509	19.30	99.02	0.04139	0.1963
60	10.9	93.55	0.2769	20.34	99.64	0.04340	0.1960
65	12.1	93.14	0.3049	21.39	100.3	0.04540	0.1957
70	13.4	92.73	0.3351	22.44	100.9	0.04738	0.1955
75	14.8	92.32	0.3676	23.49	101.5	0.04935	0.1952
80	16.3	91.91	0.4024	24.54	102.1	0.05131	0.1950
85	17.9	91.50	0.4397	25.60	102.7	0.05326	0.1948
90	19.7	91.08	0.4797	26.66	103.3	0.05519	0.1946
95	21.6	90.66	0.5224	27.73	103.9	0.05711	0.1945
100	23.6	90.23	0.5680	28.80	104.5	0.05902	0.1943
105	25.7	89.81	0.6167	29.87	105.1	0.06092	0.1942
110	28.1	89.38	0.6684	30.94	105.7	0.06281	0.1941
115	30.5	88.94	0.7235	32.02	106.3	0.06469	0.1940
120	33.2	88.51	0.7820	33.11	106.9	0.06656	0.1939
125	36.0	88.07	0.8442	34.20	107.5	0.06842	0.1939
130	38.9	87.62	0.9101	35.29	108.1	0.07027	0.1938
135	42.1	87.17	0.9799	36.39	108.7	0.07211	0.1937
140	45.4	86.72	1.054	37.49	109.3	0.07394	0.1937
145	49.0	86.26	1.132	38.59	109.9	0.07576	0.1937
150	52.8	85.80	1.215	39.70	110.5	0.07758	0.1936
155	56.7	85.33	1.302	40.82	111.0	0.07939	0.1936
160	60.9	84.86	1.394	41.94	111.6	0.08119	0.1936
165	65.3	84.39	1.492	43.06	112.2	0.08298	0.1936
170	70.0	83.91	1.594	44.19	112.7	0.08476	0.1936
175	74.9	83.42	1.702	45.33	113.3	0.08654	0.1936
180	80.0	82.93	1.816	46.47	113.8	0.08832	0.1936
185	85.4	82.43	1.936	47.62	114.4	0.09008	0.1936
190	91.1	81.93	2.062	48.77	114.9	0.09184	0.1936
195	97.1	81.42	2.195	49.93	115.4	0.09360	0.1937
200	103.3	80.90	2.335	51.09	116.0	0.09535	0.1937
205	109.8	80.38	2.482	52.26	116.5	0.09710	0.1937
210	116.7	79.85	2.636	53.44	117.0	0.09884	0.1937
215	123.8	79.31	2.799	54.62	117.5	0.1006	0.1937
220	131.3	78.76	2.970	55.82	118.0	0.1023	0.1938
225	139.1	78.21	3.149	57.01	118.5	0.1040	0.1938
230	147.2	77.65	3.338	58.22	118.9	0.1058	0.1938
235	155.6	77.08	3.536	59.43	119.4	0.1075	0.1938
240	164.5	76.50	3.745	60.65	119.8	0.1092	0.1938



Thermodynamic Properties of R-12

TEMP. (°F)	Pressure Liquid (psia)	Density Liquid (lb/ft ³)	Density Vapor (lb/ft ³)	Enthalpy Liquid (Btu/lb)	Enthalpy Vapor (Btu/lb)	Entropy Liquid (Btu/R-lb)	Entropy Vapor (Btu/R-lb)
-60	5.4	96.63	0.1537	-4.145	70.99	-0.01010	0.1779
-55	6.2	96.14	0.1756	-3.115	71.56	-0.00754	0.1770
-50	7.1	95.66	0.1999	-2.081	72.13	-0.00501	0.1761
-45	8.1	95.17	0.2268	-1.043	72.70	-0.00249	0.1753
-40	9.3	94.68	0.2565	0.000	73.27	0.00000	0.1746
-35	10.6	94.18	0.2890	1.047	73.84	0.00247	0.1739
-30	12.0	93.68	0.3247	2.098	74.41	0.00493	0.1732
-25	13.5	93.18	0.3637	3.154	74.98	0.00736	0.1726
-20	15.2	92.67	0.4063	4.214	75.55	0.00978	0.1720
-15	17.1	92.16	0.4525	5.280	76.11	0.01218	0.1715
-10	19.2	91.65	0.5028	6.350	76.68	0.01457	0.1710
-5	21.4	91.13	0.5573	7.425	77.24	0.01693	0.1705
0	23.8	90.61	0.6162	8.505	77.80	0.01929	0.1700
5	26.4	90.08	0.6798	9.591	78.35	0.02162	0.1696
10	29.3	89.55	0.7483	10.68	78.90	0.02395	0.1692
15	32.4	89.02	0.8221	11.78	79.45	0.02625	0.1688
20	35.7	88.48	0.9013	12.88	80.00	0.02855	0.1685
25	39.3	87.93	0.9864	13.99	80.54	0.03083	0.1681
30	43.1	87.38	1.078	15.10	81.07	0.03310	0.1678
35	47.2	86.82	1.175	16.22	81.61	0.03536	0.1675
40	51.6	86.25	1.279	17.35	82.13	0.03761	0.1673
45	56.3	85.68	1.391	18.48	82.65	0.03984	0.1670
50	61.3	85.10	1.510	19.62	83.17	0.04207	0.1668
55	66.6	84.52	1.637	20.77	83.68	0.04428	0.1665
60	72.3	83.92	1.772	21.92	84.18	0.04649	0.1663
65	78.4	83.32	1.915	23.08	84.67	0.04869	0.1661
70	84.8	82.71	2.068	24.25	85.16	0.05088	0.1659
75	91.5	82.09	2.231	25.43	85.64	0.05306	0.1657
80	98.7	81.47	2.404	26.61	86.11	0.05524	0.1655
85	106.3	80.83	2.588	27.80	86.58	0.05740	0.1653
90	114.3	80.18	2.783	29.01	87.03	0.05957	0.1651
95	122.7	79.52	2.991	30.22	87.47	0.06173	0.1649
100	131.6	78.85	3.211	31.44	87.90	0.06388	0.1648
105	141.0	78.16	3.445	32.67	88.32	0.06603	0.1646
110	150.8	77.46	3.694	33.91	88.73	0.06818	0.1644
115	161.1	76.75	3.958	35.16	89.12	0.07032	0.1642
120	172.0	76.02	4.238	36.43	89.50	0.07247	0.1640
125	183.3	75.28	4.537	37.70	89.87	0.07461	0.1638
130	195.2	74.51	4.855	38.99	90.22	0.07676	0.1636
135	207.7	73.73	5.193	40.30	90.55	0.07890	0.1634
140	220.7	72.93	5.554	41.61	90.86	0.08106	0.1632
145	234.4	72.10	5.939	42.95	91.15	0.08321	0.1629
150	248.6	71.24	6.351	44.30	91.42	0.08538	0.1627
155	263.5	70.36	6.792	45.67	91.66	0.08755	0.1624
160	279.0	69.45	7.265	47.06	91.87	0.08973	0.1621



R-13

R-13

Composition: 100% chlorotrifluoromethane (CClF₃)

Application: Very low temperature refrigeration

Performance:

Operates in the low temperature stage of a cascade system because of its low boiling point

Lubricant:

- o Compatible with mineral oil
- o Hydrocarbon additives are often added to a system to improve oil circulation at very low temperatures

Retrofitting:

- o Consult the comments on Page 10
- o See Ultra Low Temperature Refrigeration Section (pages 66-67)

[PRESSURE-TEMP CHART]

TEMP. (°F)	R-13 psig
-120	4.5"
-115	0.3"
-110	2.1
-105	4.7
-100	7.6
-95	10.8
-90	14.3
-85	18.2
-80	22.5
-75	27.2
-70	32.3
-65	37.8
-60	43.9
-55	50.4
-50	57.5
-45	65.1
-40	73.3
-35	82.1
-30	91.6
-25	102
-20	113
-15	122
-10	136
-5	149
0	163
5	177
10	193
15	209
20	226
25	244
30	264
35	284
40	305

[PHYSICAL PROPERTIES OF REFRIGERANTS]

	National R-13
Environmental Classification	CFC
Molecular Weight	104.5
Boiling Point (1atm, °F)	-114.3
Critical Pressure (psia)	567.8
Critical Temperature (°F)	84.6
Critical Density (lb./ft ³)	35.9
Liquid Density (20°F, lb./ft ³)	72.7
Vapor Density (bp, lb./ft ³)	0.4332
Heat of Vaporization (bp, BTU/lb.)	64.35
Specific Heat Liquid (20°F, BTU/lb. °F)	0.2121
Specific Heat Vapor (1atm, 20°F, BTU/lb. °F)	0.1451
Ozone Depletion Potential (CFC 11 = 1.0)	1.0
Global Warming Potential (CO ₂ = 1.0)	14400
ASHRAE Standard 34 Safety Rating	A1

[AVAILABLE IN SIZES]

REFRIGERANT	[AVAILABLE IN SIZES]	
	Type	Size
R-13	Cylinder	5 lb.



Thermodynamic Properties of R-13

TEMP. (°F)	Pressure Liquid (psia)	Density Liquid (lb/ft ³)	Density Vapor (lb/ft ³)	Enthalpy Liquid (Btu/lb)	Enthalpy Vapor (Btu/lb)	Entropy Liquid (Btu/R-lb)	Entropy Vapor (Btu/R-lb)
-140	6.4	98.20	0.2008	-21.91	45.08	-0.0590	0.1506
-135	7.7	97.56	0.2359	-20.89	45.58	-0.05582	0.1489
-130	9.1	96.92	0.2756	-19.86	46.08	-0.05268	0.1473
-125	10.7	96.27	0.3204	-18.82	46.57	-0.04957	0.1458
-120	12.5	95.62	0.3707	-17.78	47.06	-0.04649	0.1444
-115	14.5	94.96	0.4269	-16.73	47.55	-0.04343	0.1430
-110	16.8	94.30	0.4894	-15.67	48.03	-0.04040	0.1418
-105	19.3	93.63	0.5588	-14.61	48.51	-0.03739	0.1406
-100	22.2	92.95	0.6356	-13.54	48.98	-0.03441	0.1394
-95	25.4	92.27	0.7203	-12.46	49.45	-0.03145	0.1383
-90	28.9	91.58	0.8135	-11.37	49.91	-0.02851	0.1373
-85	32.7	90.87	0.9158	-10.28	50.37	-0.02559	0.1363
-80	37.0	90.17	1.028	-9.173	50.82	-0.02269	0.1353
-75	41.6	89.45	1.150	-8.061	51.26	-0.01980	0.1344
-70	46.7	88.72	1.283	-6.939	51.70	-0.01693	0.1335
-65	52.2	87.98	1.428	-5.809	52.12	-0.01408	0.1327
-60	58.2	87.23	1.586	-4.668	52.54	-0.01124	0.1319
-55	64.7	86.46	1.757	-3.517	52.95	-0.00841	0.1311
-50	71.7	85.69	1.942	-2.356	53.34	-0.00560	0.1304
-45	79.3	84.90	2.143	-1.184	53.73	-0.00280	0.1296
-40	87.4	84.10	2.360	0.000	54.11	0.00000	0.1289
-35	96.2	83.27	2.594	1.196	54.47	0.00279	0.1282
-30	105.6	82.44	2.848	2.405	54.82	0.00557	0.1276
-25	115.6	81.58	3.121	3.627	55.15	0.00834	0.1269
-20	126.4	80.71	3.416	4.863	55.47	0.01111	0.1262
-15	137.8	79.81	3.735	6.114	55.77	0.01388	0.1256
-10	150.0	78.89	4.078	7.381	56.06	0.01665	0.1249
-5	163.0	77.94	4.450	8.666	56.32	0.01943	0.1242
0	176.7	76.96	4.851	9.968	56.57	0.02220	0.1236
5	191.3	75.96	5.286	11.29	56.79	0.02499	0.1229
10	206.8	74.91	5.756	12.63	56.98	0.02778	0.1222
15	223.1	73.83	6.267	14.00	57.15	0.03059	0.1215
20	240.4	72.71	6.823	15.39	57.28	0.03342	0.1207
25	258.6	71.54	7.430	16.81	57.38	0.03627	0.1200
30	277.9	70.31	8.094	18.27	57.43	0.03915	0.1191
35	298.2	69.01	8.824	19.76	57.44	0.04206	0.1182
40	319.5	67.64	9.632	21.29	57.39	0.04503	0.1173



R-22

R-22

Composition: 100% chlorodifluoromethane (CHClF₂)

Applications:

Medium and low temperature commercial and industrial refrigeration; residential and commercial air conditioning

Performance: Industry standard choice for AC until 2010

Lubricant:

Compatible with mineral oil, alkylbenzene and polyolester

Retrofitting:

- o Consult the comments on Pages 9 and 10
- o See Section II, pages 92-98 for detailed discussion

[PRESSURE-TEMP CHART]

TEMP. (°F)	R-22 psig
-40	0.5
-35	2.6
-30	4.9
-25	7.4
-20	10.1
-15	13.2
-10	16.5
-5	20.1
0	24.0
5	28.2
10	32.8
15	37.7
20	43.0
25	48.8
30	54.9
35	61.5
40	68.5
45	76.0
50	84.0
55	92.6
60	102
65	111
70	121
75	132
80	144
85	156
90	168
95	182
100	196
105	211
110	226
115	243
120	260
125	278
130	297
135	317
140	337
145	359
150	382

[PHYSICAL PROPERTIES OF REFRIGERANTS]

	National R-22
Environmental Classification	HCFC
Molecular Weight	86.5
Boiling Point (1atm, °F)	-41.5
Critical Pressure (psia)	723.7
Critical Temperature (°F)	205.1
Critical Density (lb./ft ³)	32.7
Liquid Density (70°F, lb./ft ³)	75.3
Vapor Density (bp.lb./ft ³)	0.294
Heat of Vaporization (bp, BTU/lb.)	100.5
Specific Heat Liquid (70°F, BTU/lb. °F)	0.2967
Specific Heat Vapor (1atm, 70°F, BTU/lb. °F)	0.1573
Ozone Depletion Potential (CFC 11 = 1.0)	0.05
Global Warming Potential (CO ₂ = 1.0)	1810
ASHRAE Standard 34 Safety Rating	A1

[AVAILABLE IN SIZES]

REFRIGERANT	Type	Size
	R-22	Cylinder
50 lb.		
125 lb.		
1000 lb.		
1750 lb.		



Thermodynamic Properties of R-22

TEMP. (°F)	Pressure Liquid (psia)	Density Liquid (lb/ft ³)	Density Vapor (lb/ft ³)	Enthalpy Liquid (Btu/lb)	Enthalpy Vapor (Btu/lb)	Entropy Liquid (Btu/R-lb)	Entropy Vapor (Btu/R-lb)
-60	8.8	89.82	0.1827	-5.189	98.09	-0.01264	0.2458
-55	10.2	89.33	0.2087	-3.897	98.66	-0.00943	0.2440
-50	11.7	88.83	0.2374	-2.602	99.22	-0.00626	0.2423
-45	13.4	88.33	0.2692	-1.303	99.79	-0.00311	0.2407
-40	15.3	87.82	0.3042	0.000	100.3	0.00000	0.2391
-35	17.3	87.32	0.3427	1.308	100.9	0.00309	0.2376
-30	19.6	86.80	0.3849	2.620	101.4	0.00615	0.2361
-25	22.1	86.29	0.4310	3.937	102.0	0.00918	0.2348
-20	24.9	85.76	0.4813	5.260	102.5	0.01220	0.2334
-15	27.9	85.24	0.5360	6.588	103.0	0.01519	0.2321
-10	31.2	84.71	0.5955	7.923	103.6	0.01815	0.2309
-5	34.8	84.17	0.6600	9.263	104.1	0.02110	0.2296
0	38.7	83.63	0.7299	10.61	104.6	0.02403	0.2285
5	43.0	83.08	0.8054	11.96	105.1	0.02694	0.2273
10	47.5	82.52	0.8868	13.33	105.6	0.02983	0.2263
15	52.5	81.96	0.9746	14.69	106.1	0.03270	0.2252
20	57.8	81.39	1.069	16.07	106.5	0.03556	0.2242
25	63.5	80.82	1.171	17.46	107.0	0.03841	0.2231
30	69.7	80.24	1.280	18.85	107.4	0.04124	0.2222
35	76.2	79.65	1.396	20.25	107.9	0.04406	0.2212
40	83.3	79.05	1.522	21.66	108.3	0.04686	0.2203
45	90.8	78.44	1.656	23.08	108.7	0.04966	0.2194
50	98.8	77.83	1.799	24.51	109.1	0.05244	0.2185
55	107.3	77.20	1.952	25.96	109.5	0.05522	0.2176
60	116.3	76.57	2.116	27.41	109.9	0.05798	0.2167
65	125.9	75.92	2.291	28.87	110.3	0.06074	0.2159
70	136.1	75.27	2.478	30.35	110.6	0.06350	0.2150
75	146.9	74.60	2.678	31.84	110.9	0.06625	0.2142
80	158.3	73.92	2.891	33.34	111.2	0.06899	0.2133
85	170.4	73.23	3.118	34.86	111.5	0.07173	0.2125
90	183.1	72.52	3.361	36.39	111.8	0.07447	0.2117
95	196.5	71.80	3.620	37.94	112.0	0.07721	0.2108
100	210.6	71.06	3.897	39.50	112.3	0.07996	0.2100
105	225.5	70.30	4.193	41.08	112.5	0.08270	0.2091
110	241.1	69.52	4.510	42.69	112.7	0.08545	0.2083
115	257.5	68.72	4.849	44.31	112.8	0.08821	0.2074
120	274.7	67.90	5.213	45.95	112.9	0.09098	0.2065
125	292.7	67.05	5.604	47.62	113.0	0.09376	0.2056
130	311.6	66.18	6.024	49.32	113.0	0.09656	0.2046
135	331.4	65.27	6.477	51.04	113.0	0.09937	0.2036
140	352.1	64.32	6.966	52.80	113.0	0.1022	0.2026
145	373.7	63.34	7.497	54.59	112.9	0.1051	0.2015
150	396.4	62.31	8.075	56.42	112.8	0.1080	0.2004
155	420.0	61.22	8.706	58.31	112.5	0.1110	0.1992
160	444.7	60.07	9.400	60.24	112.2	0.1140	0.1979



R-23

R-23

Composition: 100% trifluoromethane (CHF₃)

Application:

Very low temperature refrigeration

Performance:

Operates in the low temperature stage of a cascade system because of its low boiling point

Lubricant:

- Polyolester lubricant
- Hydrocarbon additives are often added to a system to improve oil circulation at very low temperatures

Retrofitting:

- Consult the comments on Page 10
- See Ultra-Low Temperature Refrigeration Section — page 66-67

[PRESSURE-TEMP CHART]

TEMP. (°F)	R-23 psig
-125	7.8"
-120	4.0"
-115	0.3
-110	2.9
-105	5.8
-100	9.0
-95	12.7
-90	16.7
-85	21.3
-80	26.3
-75	31.8
-70	37.9
-65	44.6
-60	52.0
-55	60.0
-50	68.7
-45	78.1
-40	88.3
-35	99.4
-30	111
-25	124
-20	138
-15	152
-10	168
-5	185
0	203
5	222
10	242
15	264
20	287

[PHYSICAL PROPERTIES OF REFRIGERANTS]

	National R-23
Environmental Classification	HFC
Molecular Weight	70
Boiling Point (1atm, °F)	-115.6
Critical Pressure (psia)	701.4
Critical Temperature (°F)	78.7
Critical Density (lb./ft ³)	32.8
Liquid Density (20°F, lb./ft ³)	67.46
Vapor Density (bp.lb./ft ³)	0.29
Heat of Vaporization (bp, BTU/lb.)	102.7
Specific Heat Liquid (20°F, BTU/lb. °F)	0.4063
Specific Heat Vapor (1atm, 20°F, BTU/lb. °F)	0.1663
Ozone Depletion Potential (CFC 11 = 1.0)	0
Global Warming Potential (CO ₂ = 1.0)	14800
ASHRAE Standard 34 Safety Rating	A1

[AVAILABLE IN SIZES]

REFRIGERANT	Type	
	Type	Size
R-23	Cylinder	5 lb.
		9 lb.
		20 lb.
		70 lb.



Thermodynamic Properties of R-23

TEMP. (°F)	Pressure Liquid (psia)	Density Liquid (lb/ft ³)	Density Vapor (lb/ft ³)	Enthalpy Liquid (Btu/lb)	Enthalpy Vapor (Btu/lb)	Entropy Liquid (Btu/R-lb)	Entropy Vapor (Btu/R-lb)
-140	6.3	92.72	0.1312	-30.60	77.43	-0.08247	0.2555
-135	7.6	92.20	0.1562	-29.15	77.98	-0.07799	0.2520
-130	9.1	91.66	0.1850	-27.70	78.52	-0.07356	0.2486
-125	10.8	91.12	0.2178	-26.25	79.05	-0.06919	0.2455
-120	12.8	90.57	0.2550	-24.78	79.58	-0.06486	0.2424
-115	15.1	90.00	0.2972	-23.31	80.09	-0.06058	0.2394
-110	17.6	89.43	0.3446	-21.84	80.59	-0.05634	0.2366
-105	20.6	88.84	0.3978	-20.35	81.09	-0.05214	0.2339
-100	23.8	88.24	0.4572	-18.86	81.56	-0.04798	0.2312
-95	27.5	87.63	0.5234	-17.35	82.03	-0.04385	0.2287
-90	31.6	87.00	0.5970	-15.84	82.48	-0.03975	0.2262
-85	36.1	86.36	0.6784	-14.32	82.92	-0.03568	0.2238
-80	41.2	85.70	0.7684	-12.78	83.34	-0.03163	0.2215
-75	46.7	85.03	0.8675	-11.23	83.75	-0.02762	0.2193
-70	52.9	84.35	0.9765	-9.671	84.14	-0.02362	0.2171
-65	59.6	83.64	1.096	-8.097	84.51	-0.01964	0.2150
-60	67.0	82.93	1.227	-6.509	84.86	-0.01569	0.2129
-55	75.0	82.19	1.370	-4.906	85.19	-0.01175	0.2109
-50	83.7	81.43	1.527	-3.288	85.50	-0.00782	0.2089
-45	93.2	80.66	1.698	-1.653	85.79	-0.00390	0.2070
-40	103.5	79.86	1.884	0.000	86.06	0.00000	0.2051
-35	114.6	79.04	2.087	1.671	86.30	0.00390	0.2032
-30	126.6	78.20	2.307	3.361	86.52	0.00779	0.2013
-25	139.5	77.34	2.547	5.072	86.70	0.01168	0.1995
-20	153.3	76.44	2.808	6.806	86.86	0.01556	0.1976
-15	168.1	75.52	3.092	8.563	86.98	0.01946	0.1958
-10	184.0	74.57	3.402	10.34	87.06	0.02335	0.1940
-5	201.0	73.58	3.739	12.15	87.11	0.02726	0.1921
0	219.1	72.55	4.106	13.99	87.11	0.03119	0.1903
5	238.4	71.49	4.508	15.87	87.07	0.03513	0.1884
10	258.9	70.38	4.948	17.77	86.97	0.03910	0.1864
15	280.8	69.22	5.431	19.72	86.81	0.04310	0.1844
20	303.9	68.00	5.963	21.71	86.59	0.04715	0.1824
25	328.5	66.72	6.551	23.76	86.28	0.05124	0.1802
30	354.6	65.36	7.206	25.86	85.89	0.05541	0.1780
35	382.1	63.92	7.940	28.03	85.39	0.05966	0.1756
40	411.3	62.36	8.769	30.28	84.75	0.06402	0.1730



R-32

R-32

Composition: 100% difluoromethane (CH₂F₂)

Application:

Appliances and residential air conditioning

Performance:

Similar in operation to R-410A

Lubricant:

Polyolester

Retrofitting:

- Not for retrofitting — new equipment only

[PRESSURE-TEMP CHART]

TEMP. (°F)	R-32 psig
-40	11.0
-35	14.4
-30	18.2
-25	22.3
-20	26.8
-15	31.7
-10	37.1
-5	42.9
0	49.2
5	56.1
10	63.5
15	71.4
20	80.0
25	89.2
30	99.1
35	110
40	121
45	133
50	146
55	160
60	174
65	189
70	206
75	223
80	241
85	261
90	281
95	303
100	326
105	350
110	375
115	401
120	429
125	459
130	489
135	522
140	556
145	591
150	629

[PHYSICAL PROPERTIES OF REFRIGERANTS]

	National R-32
Environmental Classification	HFC
Molecular Weight	52
Boiling Point (1atm, °F)	-62
Critical Pressure (psia)	839
Critical Temperature (°F)	173
Critical Density (lb./ft ³)	26.5
Liquid Density (20 °F, lb./ft ³)	61.0
Vapor Density (bp, lb./ft ³)	0.1865
Heat of Vaporization (bp, BTU/lb.)	164.3
Specific Heat Liquid (20 °F, BTU/lb. °F)	0.4533
Specific Heat Vapor (1atm, 20 °F, BTU/lb. °F)	0.2016
Ozone Depletion Potential (CFC 11 = 1.0)	0
Global Warming Potential (CO ₂ = 1.0)	675
ASHRAE Standard 34 Safety Rating	A2

[AVAILABLE IN SIZES]

REFRIGERANT	Type	Size
	R-32	Cylinder



Thermodynamic Properties of R-32

TEMP. (°F)	Pressure Liquid (psia)	Density Liquid (lb/ft ³)	Density Vapor (lb/ft ³)	Enthalpy Liquid (Btu/lb)	Enthalpy Vapor (Btu/lb)	Entropy Liquid (Btu/R-lb)	Entropy Vapor (Btu/R-lb)
-40	25.7	73.68	0.3162	0	158.7	0	0.3781
-35	29.1	73.18	0.3557	1.928	159.2	0.004548	0.3749
-30	32.9	72.67	0.3990	3.864	159.7	0.009057	0.3718
-25	37.0	72.16	0.4464	5.808	160.2	0.01353	0.3687
-20	41.5	71.65	0.4981	7.761	160.7	0.01797	0.3658
-15	46.4	71.12	0.5545	9.723	161.1	0.02238	0.3629
-10	51.8	70.60	0.6159	11.69	161.6	0.02676	0.3601
-5	57.6	70.06	0.6825	13.68	162.0	0.03111	0.3573
0	63.9	69.52	0.7548	15.67	162.4	0.03543	0.3546
5	70.8	68.97	0.8332	17.67	162.8	0.03973	0.3520
10	78.2	68.42	0.9180	19.69	163.1	0.04400	0.3494
15	86.1	67.86	1.010	21.72	163.5	0.04825	0.3469
20	94.7	67.29	1.109	23.76	163.8	0.05248	0.3443
25	104	66.71	1.215	25.82	164.0	0.05670	0.3419
30	114	66.12	1.331	27.89	164.3	0.06090	0.3394
35	124	65.52	1.455	29.98	164.5	0.06508	0.3370
40	136	64.91	1.588	32.09	164.7	0.06926	0.3346
45	148	64.29	1.732	34.22	164.8	0.07342	0.3323
50	161	63.66	1.887	36.36	165.0	0.07758	0.3299
55	174	63.01	2.054	38.53	165.0	0.08173	0.3275
60	189	62.35	2.234	40.71	165.1	0.08588	0.3252
65	204	61.68	2.427	42.93	165.1	0.09002	0.3228
70	221	60.99	2.636	45.17	165.0	0.09418	0.3205
75	238	60.28	2.861	47.43	164.9	0.09833	0.3181
80	256	59.56	3.103	49.73	164.8	0.1025	0.3157
85	276	58.81	3.365	52.06	164.6	0.1067	0.3133
90	296	58.04	3.648	54.42	164.3	0.1109	0.3109
95	318	57.25	3.954	56.82	164.0	0.1151	0.3084
100	340	56.43	4.287	59.27	163.6	0.1194	0.3058
105	364	55.58	4.649	61.76	163.2	0.1237	0.3032
110	390	54.69	5.043	64.30	162.6	0.1280	0.3005
115	416	53.77	5.475	66.91	162.0	0.1324	0.2978
120	444	52.80	5.949	69.58	161.2	0.1369	0.2949
125	473	51.77	6.473	72.33	160.3	0.1414	0.2919
130	504	50.69	7.054	75.16	159.3	0.1460	0.2887
135	537	49.53	7.705	78.11	158.1	0.1508	0.2853
140	570	48.28	8.441	81.18	156.7	0.1557	0.2817
145	606	46.91	9.284	84.42	155.1	0.1609	0.2777
150	644	45.40	10.27	87.86	153.1	0.1663	0.2733



R-123 and R-124

R-123

Composition: 100% 2,2-dichloro 1,1,1-trifluoroethane (CF₃CHCl₂)

Application: Large, low pressure centrifugal chillers

Performance:

May require replacement of seals, gaskets, and other components to obtain the correct operating conditions and prevent leakage

Lubricant:

Compatible with mineral oil and alkylbenzene

Retrofitting:

- Consult equipment manufacturer to retrofit R-11 chiller to R-123

R-124

Composition: 100% 2-chloro 1,1,1,2-tetrafluoroethane (CF₃CHClF)

Application: High ambient air conditioning

Performance:

Slightly higher pressures and slightly lower capacity when used in an R-114 system

Lubricant:

Compatible with mineral oil and alkylbenzene

Retrofitting:

- for R-114 (Consult equipment manufacturer's guidelines)

[PRESSURE-TEMP CHART]

R-123 psig	TEMP. (°F)	R-124 psig
27.8"	-20	16.1"
27.4"	-15	14.1"
26.9"	-10	12.0"
26.4"	-5	9.6"
25.9"	0	6.9"
25.2"	5	3.9"
24.5"	10	0.6"
23.8"	15	1.6
22.8"	20	3.5
21.8"	25	5.7
20.7"	30	8.1
19.5"	35	10.5
18.1"	40	13.2
16.6"	45	16.1
14.9"	50	19.2
13.0"	55	22.6
11.2"	60	26.3
8.9"	65	30.2
6.5"	70	34.4
4.1"	75	38.9
1.2"	80	43.7
0.9	85	48.8
2.5	90	54.2
4.3	95	60.0
6.1	100	66.1
8.1	105	72.6
10.3	110	79.5
12.6	115	86.8
15.1	120	94.5
17.8	125	103
20.6	130	111
23.6	135	120
26.8	140	130
30.2	145	140
33.9	150	150

[PHYSICAL PROPERTIES OF REFRIGERANTS]

	National R-123	National R-124
Environmental Classification	HCFC	HCFC
Molecular Weight	152.9	136.5
Boiling Point (1atm, °F)	82.1	10.3
Critical Pressure (psia)	531.1	527.1
Critical Temperature (°F)	362.6	252.5
Critical Density (lb./ft ³)	34.3	34.6
Liquid Density (70 °F, lb./ft ³)	91.95	85.5
Vapor Density (bp, lb./ft ³)	0.404	0.419
Heat of Vaporization (bp, BTU/lb.)	73.2	70.6
Specific Heat Liquid (70 °F, BTU/lb. °F)	0.2329	0.265
Specific Heat Vapor (1atm, 70 °F, BTU/lb. °F)	0.1645(sat)	0.1762
Ozone Depletion Potential (CFC 11 = 1.0)	0.0015	0.03
Global Warming Potential (CO ₂ = 1.0)	77	609
ASHRAE Standard 34 Safety Rating	B1	A1

[AVAILABLE IN SIZES]

REFRIGERANT	Type	Size
R-123	Drum	100 lb.
		200 lb.
		650 lb.
R-124	Cylinder	30 lb.
	Cylinder	145 lb.



Thermodynamic Properties of R-123

TEMP. (°F)	Pressure Liquid (psia)	Density Liquid (lb/ft ³)	Density Vapor (lb/ft ³)	Enthalpy Liquid (Btu/lb)	Enthalpy Vapor (Btu/lb)	Entropy Liquid (Btu/R-lb)	Entropy Vapor (Btu/R-lb)
-20	1.0	99.54	0.03413	4.558	87.35	0.01061	0.1989
-15	1.2	99.14	0.03978	5.706	88.05	0.01320	0.1984
-10	1.4	98.73	0.04618	6.857	88.75	0.01578	0.1979
-5	1.7	98.33	0.05339	8.012	89.46	0.01833	0.1975
0	2.0	97.92	0.06149	9.170	90.16	0.02086	0.1971
5	2.3	97.51	0.07055	10.33	90.87	0.02337	0.1967
10	2.6	97.10	0.08067	11.50	91.58	0.02587	0.1964
15	3.0	96.69	0.09192	12.67	92.29	0.02834	0.1961
20	3.5	96.28	0.1044	13.84	93.01	0.03080	0.1958
25	4.0	95.86	0.1182	15.02	93.72	0.03324	0.1956
30	4.5	95.44	0.1334	16.20	94.44	0.03566	0.1954
35	5.1	95.02	0.1502	17.38	95.16	0.03806	0.1953
40	5.8	94.60	0.1686	18.57	95.88	0.04045	0.1952
45	6.5	94.17	0.1887	19.76	96.60	0.04282	0.1951
50	7.3	93.74	0.2106	20.96	97.32	0.04518	0.1950
55	8.2	93.31	0.2346	22.16	98.04	0.04752	0.1950
60	9.2	92.88	0.2606	23.36	98.76	0.04984	0.1949
65	10.3	92.44	0.2889	24.57	99.48	0.05215	0.1949
70	11.4	92.01	0.3195	25.78	100.2	0.05444	0.1949
75	12.7	91.56	0.3526	27.00	100.9	0.05673	0.1950
80	14.1	91.12	0.3883	28.22	101.6	0.05899	0.1950
85	15.6	90.67	0.4268	29.44	102.4	0.06124	0.1951
90	17.2	90.22	0.4682	30.67	103.1	0.06348	0.1952
95	18.9	89.77	0.5128	31.90	103.8	0.06571	0.1953
100	20.8	89.31	0.5605	33.14	104.5	0.06792	0.1955
105	22.8	88.85	0.6117	34.38	105.2	0.07012	0.1956
110	25.0	88.39	0.6664	35.63	106.0	0.07231	0.1958
115	27.3	87.92	0.7249	36.88	106.7	0.07449	0.1959
120	29.8	87.45	0.7874	38.13	107.4	0.07665	0.1961
125	32.4	86.98	0.8540	39.39	108.1	0.07881	0.1963
130	35.3	86.50	0.9249	40.66	108.8	0.08095	0.1965
135	38.3	86.01	1.000	41.93	109.5	0.08308	0.1967
140	41.5	85.52	1.081	43.20	110.2	0.08520	0.1969
145	44.9	85.03	1.166	44.48	110.9	0.08732	0.1972
150	48.5	84.53	1.256	45.76	111.6	0.08942	0.1974
155	52.3	84.03	1.353	47.05	112.3	0.09151	0.1976
160	56.4	83.52	1.454	48.35	113.0	0.09359	0.1979
165	60.7	83.01	1.562	49.65	113.7	0.09567	0.1981
170	65.2	82.49	1.676	50.95	114.3	0.09773	0.1984
175	70.0	81.96	1.797	52.27	115.0	0.09979	0.1987
180	75.0	81.43	1.925	53.58	115.7	0.1018	0.1989
185	80.3	80.89	2.060	54.91	116.3	0.1039	0.1992
190	85.9	80.34	2.203	56.24	117.0	0.1059	0.1995
195	91.7	79.79	2.354	57.57	117.7	0.1079	0.1997
200	97.9	79.23	2.513	58.92	118.3	0.1100	0.2000



Thermodynamic Properties of R-124

TEMP. (°F)	Pressure Liquid (psia)	Density Liquid (lb/ft ³)	Density Vapor (lb/ft ³)	Enthalpy Liquid (Btu/lb)	Enthalpy Vapor (Btu/lb)	Entropy Liquid (Btu/R-lb)	Entropy Vapor (Btu/R-lb)
-40	3.8	97.03	0.1181	0	76.75	0	0.1829
-35	4.5	96.55	0.1359	1.222	77.46	0.00289	0.1824
-30	5.2	96.06	0.1557	2.449	78.17	0.00576	0.1820
-25	5.9	95.57	0.1779	3.681	78.88	0.00861	0.1816
-20	6.8	95.08	0.2024	4.918	79.59	0.01143	0.1813
-15	7.8	94.58	0.2295	6.159	80.30	0.01424	0.1810
-10	8.9	94.08	0.2594	7.406	81.01	0.01702	0.1807
-5	10.1	93.57	0.2924	8.657	81.72	0.01978	0.1805
0	11.4	93.06	0.3285	9.914	82.43	0.02253	0.1803
5	12.9	92.55	0.3680	11.18	83.14	0.02525	0.1801
10	14.5	92.04	0.4112	12.44	83.84	0.02796	0.1800
15	16.3	91.52	0.4583	13.72	84.55	0.03065	0.1799
20	18.3	90.99	0.5095	15.00	85.25	0.03332	0.1798
25	20.4	90.46	0.5651	16.28	85.95	0.03597	0.0797
30	22.7	89.93	0.6253	17.57	86.65	0.03861	0.1797
35	25.2	89.39	0.6904	18.87	87.35	0.04124	0.1797
40	27.9	88.84	0.7608	20.17	88.05	0.04385	0.1797
45	30.8	88.29	0.8366	21.48	88.74	0.04644	0.1797
50	34.0	87.73	0.9183	22.80	89.43	0.04902	0.1798
55	37.4	87.17	1.006	24.12	90.11	0.05159	0.1798
60	41.0	86.60	1.100	25.45	90.79	0.05415	0.1799
65	44.9	86.03	1.202	26.79	91.47	0.05669	0.1800
70	49.1	85.44	1.310	28.13	92.14	0.05922	0.1801
75	53.6	84.85	1.426	29.48	92.81	0.06174	0.1802
80	58.4	84.25	1.551	30.84	93.47	0.06425	0.1803
85	63.5	83.65	1.683	32.21	94.13	0.06676	0.1804
90	69.0	83.03	1.825	33.58	94.78	0.06925	0.1806
95	74.8	82.41	1.977	34.97	95.42	0.07173	0.1807
100	80.9	81.77	2.139	36.36	96.06	0.07420	0.1809
105	87.4	81.13	2.311	37.76	96.69	0.07667	0.1810
110	94.3	80.48	2.495	39.17	97.31	0.07913	0.1812
115	101.6	79.81	2.691	40.59	97.92	0.08158	0.1813
120	109.3	79.13	2.900	42.02	98.53	0.08403	0.1815
125	117.5	78.44	3.123	43.46	99.12	0.08648	0.1817
130	126.0	77.73	3.360	44.92	99.70	0.08892	0.1818
135	135.1	77.01	3.614	46.38	100.3	0.09135	0.1820
140	144.6	76.28	3.884	47.86	100.8	0.09379	0.1821
145	154.6	75.52	4.172	49.35	101.4	0.09622	0.1823
150	165.1	74.75	4.480	50.85	101.9	0.09866	0.1824
155	176.2	73.96	4.809	52.37	102.4	0.1011	0.1825
160	187.7	73.14	5.161	53.91	102.9	0.1035	0.1826
165	199.9	72.30	5.538	55.46	103.4	0.1060	0.1827
170	212.6	71.44	5.942	57.03	103.8	0.1084	0.1828
175	225.9	70.54	6.377	58.62	104.3	0.1109	0.1828
180	239.8	69.61	6.845	60.23	104.7	0.1134	0.1828



R-134a

R-134a

Composition: 100% 1,1,1,2-tetrafluoroethane (CF₃CH₂F)

Application:

Household appliances, refrigeration (commercial and self-contained equipment), centrifugal chillers and automotive air conditioning

Performance:

- Industry standard choice for automotive AC and small appliances
- Equipment optimized for R-134a over last 20 years

Lubricant:

Compatible with polyolester lubricant for stationary equipment and polyalkaline glycol for automotive A/C systems

Retrofitting:

- Consult the comments on Pages 9 and 10
- See Section II, pages 92-98 for detailed discussion

[PRESSURE-TEMP CHART]

TEMP. (°F)	R-134a psig
-40	14.8"
-35	12.5"
-30	9.9"
-25	6.9"
-20	3.7"
-15	0.6
-10	1.9
-5	4.0
0	6.5
5	9.1
10	11.9
15	15.0
20	18.4
25	22.1
30	26.1
35	30.4
40	35.0
45	40.1
50	45.5
55	51.3
60	57.5
65	64.1
70	71.2
75	78.8
80	86.8
85	95.4
90	104
95	114
100	124
105	135
110	147
115	159
120	171
125	185
130	199
135	214
140	229
145	246
150	263

[PHYSICAL PROPERTIES OF REFRIGERANTS]

	National R-134a
Environmental Classification	HFC
Molecular Weight	102.3
Boiling Point (1atm, °F)	-14.9
Critical Pressure (psia)	588.3
Critical Temperature (°F)	213.8
Critical Density (lb./ft ³)	32.0
Liquid Density (70 °F, lb./ft ³)	76.2
Vapor Density (bp, lb./ft ³)	0.328
Heat of Vaporization (bp, BTU/lb.)	93.3
Specific Heat Liquid (70 °F, BTU/lb. °F)	0.3366
Specific Heat Vapor (1atm, 70 °F, BTU/lb. °F)	0.2021
Ozone Depletion Potential (CFC 11 = 1.0)	0
Global Warming Potential (CO2 = 1.0)	1430
ASHRAE Standard 34 Safety Rating	A1

[AVAILABLE IN SIZES]

REFRIGERANT	Type	Size
R-134a	Can	12 oz.
	Cylinder	30 lb.
		30 lb. Automotive Fitting
		125 lb.
		1,000 lb.
		1,750 lb.



Thermodynamic Properties of R-134a

TEMP. (°F)	Pressure Liquid (psia)	Density Liquid (lb/ft ³)	Density Vapor (lb/ft ³)	Enthalpy Liquid (Btu/lb)	Enthalpy Vapor (Btu/lb)	Entropy Liquid (Btu/R-lb)	Entropy Vapor (Btu/R-lb)
-60	4.0	90.49	0.0969	-5.957	94.13	-0.01452	0.2359
-55	4.7	90.00	0.1127	-4.476	94.89	-0.01085	0.2347
-50	5.5	89.50	0.1305	-2.989	95.65	-0.00720	0.2336
-45	6.4	89.00	0.1505	-1.498	96.41	-0.00358	0.2325
-40	7.4	88.50	0.1729	0.000	97.17	0.00000	0.2315
-35	8.6	88.00	0.1978	1.503	97.92	0.00356	0.2306
-30	9.9	87.49	0.2256	3.013	98.68	0.00708	0.2297
-25	11.3	86.98	0.2563	4.529	99.43	0.01058	0.2289
-20	12.9	86.47	0.2903	6.051	100.2	0.01406	0.2282
-15	15.3	85.95	0.3277	7.580	100.9	0.01751	0.2274
-10	16.6	85.43	0.3689	9.115	101.7	0.02093	0.2268
-5	18.8	84.90	0.4140	10.66	102.4	0.02433	0.2262
0	21.2	84.37	0.4634	12.21	103.2	0.02771	0.2256
5	23.8	83.83	0.5173	13.76	103.9	0.03107	0.2250
10	26.6	83.29	0.5761	15.33	104.6	0.03440	0.2245
15	29.7	82.74	0.6401	16.90	105.3	0.03772	0.2240
20	33.1	82.19	0.7095	18.48	106.1	0.04101	0.2236
25	36.8	81.63	0.7848	20.07	106.8	0.04429	0.2232
30	40.8	81.06	0.8663	21.67	107.5	0.04755	0.2228
35	45.1	80.49	0.9544	23.27	108.2	0.05079	0.2224
40	49.7	79.90	1.050	24.89	108.9	0.05402	0.2221
45	54.8	79.32	1.152	26.51	109.5	0.05724	0.2217
50	60.2	78.72	1.263	28.15	110.2	0.06044	0.2214
55	65.9	78.11	1.382	29.80	110.9	0.06362	0.2212
60	72.2	77.50	1.510	31.45	111.5	0.06680	0.2209
65	78.8	76.87	1.647	33.12	112.2	0.06996	0.2206
70	85.8	76.24	1.795	34.80	112.8	0.07311	0.2204
75	93.5	75.59	1.953	36.49	113.4	0.07626	0.2201
80	101.4	74.94	2.123	38.20	114.0	0.07939	0.2199
85	109.9	74.27	2.305	39.91	114.6	0.08252	0.2197
90	119.0	73.58	2.501	41.65	115.2	0.08565	0.2194
95	128.6	72.88	2.710	43.39	115.7	0.08877	0.2192
100	138.9	72.17	2.935	45.15	116.3	0.09188	0.2190
105	149.7	71.44	3.176	46.93	116.8	0.09500	0.2187
110	161.1	70.69	3.435	48.73	117.3	0.09811	0.2185
115	173.1	69.93	3.713	50.55	117.8	0.1012	0.2183
120	185.9	69.14	4.012	52.38	118.3	0.1044	0.2180
125	199.3	68.32	4.333	54.24	118.7	0.1075	0.2177
130	213.4	67.49	4.679	56.12	119.1	0.1106	0.2174
135	228.3	66.62	5.052	58.02	119.5	0.1138	0.2171
140	243.9	65.73	5.455	59.95	119.8	0.1169	0.2167
145	260.4	64.80	5.892	61.92	120.1	0.1201	0.2163
150	277.6	63.83	6.366	63.91	120.4	0.1233	0.2159
155	295.7	62.82	6.882	65.94	120.6	0.1265	0.2154
160	314.7	61.76	7.447	68.00	120.7	0.1298	0.2149



R-401A and R-401B

R-401A R-401B

Composition:

R-401A: (R-22 / 152a / 124) • (53 / 13 / 34 wt%)

R-401B: (R-22 / 152a / 124) • (61 / 11 / 28 wt%)

Replaces:

R-401A: R-12

R-401B: R-12 & R-500

Application:

R-401A: Medium and low temperature commercial and industrial direct expansion refrigeration

R-401B: Low temperature commercial and industrial direct expansion refrigeration; R-12 air conditioning; R-500 systems

Performance:

- Very similar capacity, higher temperature glide
- Similar evaporator pressure when average evaporator temperature is the same as R-12
- Head pressure runs 20 psi to 30 psi higher than R-12

Lubricant:

Compatible with a combination of mineral oil and alkylbenzene or polyolester lubricants

Retrofitting:

- Consult the comments on Pages 9 and 10
- See Section II, pages 92-98 for detailed discussion

[PHYSICAL PROPERTIES OF REFRIGERANTS]

	National R-401A	National R-401B
Environmental Classification	HCFC	HCFC
Molecular Weight	94.4	92.8
Boiling Point (1atm, °F)	-29.9	-32.3
Critical Pressure (psia)	669	679.1
Critical Temperature (°F)	221	218.3
Critical Density (lb./ft ³)	30.9	31.1
Liquid Density (70°F, lb./ft ³)	74.6	74.6
Vapor Density (bp, lb./ft ³)	0.306	0.303
Heat of Vaporization (bp, BTU/lb.)	97.5	98.2
Specific Heat Liquid (70 °F, BTU/lb. °F)	0.3037	0.3027
Specific Heat Vapor (1atm, 70 °F, BTU/lb. °F)	0.1755	0.1725
Ozone Depletion Potential (CFC 11 = 1.0)	0.037	0.039
Global Warming Potential (CO2 = 1.0)	1182	1288
ASHRAE Standard 34 Safety Rating	A1	A1
Temperature Glide (°F) (see section 2)	8	8

[PRESSURE-TEMP CHART]

R401A			R401B	
Liquid (psig)	Vapor (psig)	TEMP. (°F)	Liquid (psig)	Vapor (psig)
8.1"	13.2"	-40	6.5"	11.8"
5.1"	10.7"	-35	3.3"	9.1"
1.7"	7.9"	-30	0.2	6.1"
1.0	4.8"	-25	2.1	2.8"
3.0	1.4"	-20	4.3	0.5
5.2	1.2	-15	6.6	2.5
7.7	3.3	-10	9.2	4.7
10.3	5.5	-5	12.0	7.1
13.2	8.0	0	15.1	9.7
16.3	10.7	5	18.4	12.6
19.7	13.7	10	22.0	15.8
23.4	16.9	15	25.9	19.2
27.4	20.4	20	30.1	23.0
31.7	24.2	25	34.6	27.0
36.4	28.3	30	39.5	31.4
41.3	32.8	35	44.8	36.1
46.6	37.6	40	50.4	41.1
52.4	42.7	45	56.4	46.6
58.5	48.2	50	62.8	52.4
65.0	54.1	55	69.6	58.7
71.9	60.4	60	76.9	65.4
79.3	67.2	65	84.7	72.5
87.1	74.4	70	92.9	80.1
95.4	82.1	75	102	88.2
104	90.2	80	111	96.8
114	98.9	85	121	106
123	108	90	131	116
134	118	95	142	126
145	128	100	153	137
156	139	105	166	148
169	151	110	178	160
181	163	115	192	173
195	176	120	206	187
209	189	125	220	201
224	203	130	236	216
239	218	135	252	231
255	234	140	269	248
272	250	145	287	265
290	267	150	305	283

[AVAILABLE IN SIZES]

REFRIGERANT	Type	Size
R-401A	Cylinder	30 lb.
		125 lb.
R-401B	Cylinder	30 lb.
		125 lb.



Thermodynamic Properties of R-401A

TEMP. (°F)	Pressure Liquid (psia)	Pressure Vapor (psia)	Density Liquid (lb/ft ³)	Density Vapor (lb/ft ³)	Enthalpy Liquid (Btu/lb)	Enthalpy Vapor (Btu/lb)	Entropy Liquid (Btu/R-lb)	Entropy Vapor (Btu/R-lb)
-60	6.5	4.7	88.18	0.1049	-5.371	94.93	-0.01309	0.2418
-55	7.5	5.5	87.71	0.1215	-4.035	95.60	-0.00977	0.2402
-50	8.7	6.4	87.24	0.1401	-2.694	96.26	-0.00648	0.2386
-45	9.9	7.4	86.77	0.1610	-1.350	96.93	-0.00323	0.2372
-40	11.4	8.6	86.29	0.1842	0.000	97.59	0.00000	0.2358
-35	12.9	9.9	85.82	0.2101	1.354	98.25	0.00320	0.2345
-30	14.7	11.3	85.33	0.2386	2.714	98.91	0.00637	0.2333
-25	16.6	12.9	84.85	0.2701	4.078	99.56	0.00952	0.2321
-20	18.7	14.7	84.36	0.3048	5.449	100.2	0.01265	0.2310
-15	21.0	16.6	83.86	0.3429	6.825	100.9	0.01575	0.2299
-10	23.6	18.8	83.37	0.3846	8.207	101.5	0.01882	0.2289
-5	26.4	21.2	82.86	0.4302	9.595	102.1	0.02188	0.2279
0	29.4	23.8	82.36	0.4799	10.99	102.8	0.02492	0.2269
5	32.7	26.6	81.84	0.5340	12.39	103.4	0.02793	0.2261
10	36.2	29.7	81.33	0.5927	13.80	104.0	0.03093	0.2252
15	40.1	33.1	80.80	0.6563	15.21	104.6	0.03391	0.2244
20	44.2	36.7	80.27	0.7251	16.64	105.2	0.03687	0.2236
25	48.7	40.7	79.74	0.7995	18.07	105.8	0.03982	0.2229
30	53.5	45.0	79.20	0.8798	19.51	106.4	0.04275	0.2221
35	58.6	49.6	78.65	0.9662	20.95	107.0	0.04566	0.2214
40	64.2	54.6	78.10	1.059	22.41	107.6	0.04857	0.2208
45	70.1	59.9	77.54	1.159	23.88	108.2	0.05145	0.2201
50	76.4	65.6	76.97	1.267	25.35	108.7	0.05433	0.2195
55	83.1	71.8	76.39	1.382	26.83	109.3	0.05720	0.2189
60	90.2	78.3	75.81	1.505	28.33	109.8	0.06005	0.2183
65	97.8	85.3	75.21	1.637	29.83	110.4	0.06290	0.2178
70	105.9	92.8	74.61	1.779	31.35	110.9	0.06573	0.2172
75	114.5	100.7	74.00	1.930	32.87	111.4	0.06856	0.2167
80	123.5	109.2	73.37	2.092	34.41	111.9	0.07138	0.2162
85	133.1	118.1	72.74	2.265	35.96	112.4	0.07420	0.2156
90	143.2	127.6	72.09	2.449	37.52	112.8	0.07701	0.2151
95	153.9	137.7	71.43	2.647	39.10	113.3	0.07981	0.2146
100	165.2	148.3	70.76	2.858	40.69	113.7	0.08261	0.2141
105	177.0	159.6	70.08	3.083	42.30	114.1	0.08541	0.2136
110	189.5	171.4	69.38	3.324	43.92	114.5	0.08822	0.2131
115	202.6	183.9	68.66	3.581	45.56	114.9	0.09102	0.2126
120	216.3	197.1	67.93	3.857	47.21	115.2	0.09382	0.2120
125	230.7	211.0	67.17	4.152	48.89	115.6	0.09663	0.2115
130	245.8	225.6	66.40	4.468	50.58	115.9	0.09945	0.2110
135	261.7	240.9	65.60	4.807	52.30	116.2	0.1023	0.2104
140	278.2	257.1	64.77	5.171	54.04	116.4	0.1051	0.2098
145	295.5	274.0	63.92	5.564	55.81	116.6	0.1080	0.2092
150	313.6	291.7	63.04	5.987	57.61	116.8	0.1108	0.2085
155	332.6	310.3	62.12	6.444	59.43	116.9	0.1137	0.2078



Thermodynamic Properties of R-401B

TEMP. (°F)	Pressure Liquid (psia)	Pressure Vapor (psia)	Density Liquid (lb/ft ³)	Density Vapor (lb/ft ³)	Enthalpy Liquid (Btu/lb)	Enthalpy Vapor (Btu/lb)	Entropy Liquid (Btu/R-lb)	Entropy Vapor (Btu/R-lb)
-60	6.9	5.2	88.34	0.1145	-5.346	95.56	-0.01302	0.2430
-55	8.0	6.1	87.87	0.1324	-4.016	96.21	-0.00972	0.2414
-50	9.2	7.1	87.40	0.1524	-2.681	96.86	-0.00645	0.2398
-45	10.6	8.2	86.92	0.1748	-1.343	97.51	-0.00321	0.2383
-40	12.1	9.4	86.44	0.1997	0.000	98.16	0.00000	0.2369
-35	13.7	10.8	85.96	0.2273	1.348	98.80	0.00318	0.2355
-30	15.6	12.4	85.47	0.2577	2.701	99.44	0.00634	0.2343
-25	17.6	14.1	84.98	0.2914	4.059	100.1	0.00947	0.2330
-20	19.8	16.0	84.48	0.3283	5.422	100.7	0.01258	0.2318
-15	22.3	18.1	83.99	0.3688	6.791	101.3	0.01567	0.2307
-10	25.0	20.5	83.48	0.4131	8.166	102.0	0.01873	0.2296
-5	27.9	23.0	82.97	0.4614	9.548	102.6	0.02177	0.2286
0	31.1	25.8	82.46	0.5140	10.94	103.2	0.02479	0.2276
5	34.5	28.9	81.94	0.5713	12.33	103.8	0.02779	0.2267
10	38.3	32.2	81.42	0.6333	13.73	104.4	0.03077	0.2258
15	42.3	35.8	80.89	0.7005	15.14	105.0	0.03374	0.2249
20	46.7	39.7	80.35	0.7732	16.56	105.6	0.03669	0.2241
25	51.4	43.9	79.81	0.8516	17.98	106.2	0.03962	0.2233
30	56.4	48.5	79.26	0.9362	19.42	106.7	0.04253	0.2225
35	61.8	53.4	78.71	1.027	20.86	107.3	0.04544	0.2218
40	67.6	58.7	78.15	1.125	22.31	107.8	0.04832	0.2211
45	73.8	64.4	77.58	1.230	23.76	108.4	0.05120	0.2204
50	80.4	70.5	77.00	1.343	25.23	108.9	0.05406	0.2197
55	87.5	77.0	76.42	1.464	26.71	109.5	0.05692	0.2190
60	95.0	84.0	75.82	1.594	28.20	110.0	0.05976	0.2184
65	103	91.4	75.22	1.732	29.70	110.5	0.06259	0.2178
70	111	99.3	74.61	1.881	31.21	111.0	0.06542	0.2172
75	120	108	73.99	2.039	32.73	111.4	0.06824	0.2166
80	130	117	73.36	2.209	34.26	111.9	0.07105	0.2160
85	140	126	72.71	2.390	35.81	112.4	0.07385	0.2154
90	150	136	72.06	2.584	37.37	112.8	0.07665	0.2149
95	162	147	71.39	2.791	38.94	113.2	0.07945	0.2143
100	173	158	70.70	3.012	40.53	113.6	0.08224	0.2137
105	186	170	70.01	3.248	42.13	114.0	0.08504	0.2131
110	199	182	69.29	3.501	43.75	114.3	0.08783	0.2126
115	212	195	68.56	3.771	45.39	114.7	0.09063	0.2120
120	227	209	67.81	4.060	47.05	115.0	0.09343	0.2114
125	242	224	67.04	4.369	48.72	115.3	0.09624	0.2108
130	258	239	66.25	4.701	50.42	115.5	0.09905	0.2102
135	274	255	65.44	5.058	52.14	115.8	0.1019	0.2095
140	291	272	64.59	5.441	53.88	116.0	0.1047	0.2089
145	309	290	63.72	5.854	55.66	116.1	0.1076	0.2082
150	328	309	62.81	6.300	57.46	116.3	0.1105	0.2074
155	348	328	61.87	6.783	59.30	116.3	0.1134	0.2067



R-402A and R-402B

R-402A

Composition: (R-125 / 290 / 22) • (60 / 2 / 38 wt%)

Replaces: R-502

Application: Low temperature commercial and industrial refrigeration

Performance:

Lower discharge temperature, higher discharge pressure

Lubricant:

Compatible with mineral oil, alkylbenzene, or polyolester.

Retrofitting:

- Consult the comments on Pages 9 and 10
- See Section II, pages 92-98 for detailed discussion

R-402B

Composition: (R-125 / 290 / 22) • (38 / 2 / 60 wt%)

Replaces: R-502

Application: Ice Machines

Performance:

Higher discharge temperature, lower discharge pressure

Lubricant:

Compatible with mineral oil, alkylbenzene, or polyolester.

Retrofitting:

- Consult the comments on Pages 9 and 10
- See Section II, pages 92-98 for detailed discussion

[PRESSURE-TEMP CHART]

R-402A psig	TEMP. (°F)	R-402B psig
6.3	-40	3.6
9.1	-35	6.0
12.1	-30	9.0
15.4	-25	12.0
18.9	-20	15.4
22.9	-15	18.6
27.1	-10	22.6
31.7	-5	27.0
36.7	0	31.0
42.1	5	36.0
48.0	10	42.0
54.2	15	47.0
60.9	20	54.0
68.1	25	60.0
75.8	30	67.0
84.0	35	75.0
92.8	40	83.4
102	45	91.6
112	50	100
123	55	110
134	60	120
146	65	133
158	70	143
171	75	155
185	80	170
200	85	183
215	90	198
232	95	213
249	100	230
267	105	247
286	110	262
305	115	283
326	120	303
347	125	323
370	130	345
393	135	367
418	140	391
443	145	-
470	150	-

[PHYSICAL PROPERTIES OF REFRIGERANTS]

	National R-402A	National R-402B
Environmental Classification	HCFC	HCFC
Molecular Weight	101.6	94.7
Boiling Point (1atm, °F)	-56.5	-52.9
Critical Pressure (psia)	600	645
Critical Temperature (°F)	168	180.7
Critical Density (lb./ft ³)	33.8	33.1
Liquid Density (70 °F, lb./ft ³)	72.61	72.81
Vapor Density (bp, lb./ft ³)	0.356	0.328
Heat of Vaporization (bp, BTU/lb.)	83.58	90.42
Specific Heat Liquid (70 °F, BTU/lb. °F)	0.3254	0.317
Specific Heat Vapor (1atm, 70 °F, BTU/lb. °F)	0.1811	0.1741
Ozone Depletion Potential (CFC 11 = 1.0)	0.019	0.03
Global Warming Potential (CO2 = 1.0)	2788	2416
ASHRAE Standard 34 Safety Rating	A1	A1
Temperature Glide (°F) (see section 2)	2.5	2.5

[AVAILABLE IN SIZES]

REFRIGERANT	Type	Size
R-402A	Cylinder	27 lb.
		110 lb.
R-402B	Cylinder	13 lb.



Thermodynamic Properties of R-402A

TEMP. (°F)	Pressure Liquid (psia)	Pressure Vapor (psia)	Density Liquid (lb/ft ³)	Density Vapor (lb/ft ³)	Enthalpy Liquid (Btu/lb)	Enthalpy Vapor (Btu/lb)	Entropy Liquid (Btu/R-lb)	Entropy Vapor (Btu/R-lb)
-60	13.4	12.0	89.70	0.2946	-5.410	78.16	-0.01316	0.1968
-55	15.3	13.8	89.14	0.3355	-4.067	78.80	-0.00983	0.1958
-50	17.4	15.8	88.58	0.3807	-2.718	79.45	-0.00653	0.1948
-45	19.8	18.0	88.01	0.4305	-1.362	80.09	-0.00325	0.1939
-40	22.3	20.5	87.44	0.4854	0.000	80.73	0.00000	0.1931
-35	25.2	23.2	86.86	0.5455	1.369	81.37	0.00323	0.1923
-30	28.3	26.1	86.28	0.6113	2.746	82.00	0.00644	0.1915
-25	31.7	29.4	85.69	0.6832	4.130	82.62	0.00962	0.1908
-20	35.4	32.9	85.09	0.7615	5.522	83.24	0.01279	0.1901
-15	39.4	36.8	84.48	0.8467	6.923	83.85	0.01594	0.1895
-10	43.8	41.0	83.87	0.9392	8.331	84.46	0.01906	0.1889
-5	48.6	45.6	83.25	1.039	9.749	85.06	0.02218	0.1883
0	53.7	50.6	82.62	1.148	11.18	85.65	0.02527	0.1878
5	59.2	56.0	81.99	1.265	12.61	86.23	0.02835	0.1873
10	65.2	61.7	81.34	1.392	14.06	86.81	0.03142	0.1868
15	71.6	68.0	80.68	1.528	15.52	87.37	0.03448	0.1863
20	78.4	74.7	80.02	1.675	16.98	87.93	0.03752	0.1858
25	85.8	81.8	79.34	1.834	18.46	88.48	0.04055	0.1854
30	93.6	89.5	78.65	2.004	19.95	89.01	0.04357	0.1850
35	102.0	97.7	77.95	2.187	21.46	89.53	0.04659	0.1846
40	110.9	106.4	77.24	2.383	22.97	90.05	0.04959	0.1842
45	120.3	115.8	76.51	2.595	24.50	90.54	0.05259	0.1838
50	130.4	125.7	75.76	2.821	26.04	91.02	0.05559	0.1834
55	141.1	136.2	75.00	3.065	27.60	91.49	0.05858	0.1830
60	152.4	147.4	74.23	3.326	29.18	91.94	0.06157	0.1826
65	164.4	159.2	73.43	3.607	30.77	92.37	0.06456	0.1822
70	177.1	171.8	72.61	3.909	32.38	92.78	0.06755	0.1818
75	190.5	185.0	71.78	4.233	34.00	93.17	0.07054	0.1814
80	204.6	199.0	70.91	4.583	35.65	93.54	0.07354	0.1810
85	219.5	213.8	70.02	4.959	37.32	93.88	0.07654	0.1806
90	235.1	229.3	69.10	5.366	39.01	94.19	0.07956	0.1801
95	251.6	245.7	68.15	5.805	40.73	94.47	0.08259	0.1797
100	269.0	263.0	67.17	6.281	42.48	94.71	0.08564	0.1791
105	287.2	281.1	66.14	6.799	44.25	94.91	0.08871	0.1786
110	306.3	300.2	65.06	7.362	46.07	95.07	0.09181	0.1780
115	326.4	320.2	63.93	7.979	47.92	95.18	0.09494	0.1773
120	347.4	341.3	62.74	8.658	49.81	95.22	0.09812	0.1766
125	369.5	363.3	61.48	9.408	51.76	95.20	0.1013	0.1758
130	392.6	386.5	60.13	10.25	53.76	95.09	0.1046	0.1748
135	416.9	410.8	58.67	11.19	55.84	94.88	0.1080	0.1738
140	442.2	436.3	57.07	12.26	58.01	94.55	0.1115	0.1725



Thermodynamic Properties of R-402B

TEMP. (°F)	Pressure Liquid (psia)	Pressure Vapor (psia)	Density Liquid (lb/ft ³)	Density Vapor (lb/ft ³)	Enthalpy Liquid (Btu/lb)	Enthalpy Vapor (Btu/lb)	Entropy Liquid (Btu/R-lb)	Entropy Vapor (Btu/R-lb)
-60	12.2	10.8	88.76	0.2454	-5.366	85.51	-0.01306	0.2154
-55	13.9	12.4	88.23	0.2798	-4.033	86.14	-0.00975	0.2141
-50	15.9	14.2	87.70	0.3178	-2.694	86.76	-0.00647	0.2129
-45	18.0	16.2	87.16	0.3598	-1.350	87.38	-0.00322	0.2117
-40	20.4	18.5	86.62	0.4061	0.000	87.99	0.00000	0.2106
-35	23.0	20.9	86.07	0.4568	1.356	88.61	0.00320	0.2095
-30	25.9	23.6	85.52	0.5124	2.719	89.21	0.00638	0.2085
-25	29.1	26.6	84.96	0.5731	4.089	89.81	0.00953	0.2075
-20	32.5	29.9	84.40	0.6392	5.466	90.40	0.01266	0.2066
-15	36.2	33.4	83.83	0.7112	6.850	90.99	0.01577	0.2057
-10	40.3	37.3	83.25	0.7894	8.242	91.57	0.01887	0.2049
-5	44.7	41.5	82.67	0.8742	9.643	92.15	0.02194	0.2041
0	49.5	46.1	82.08	0.9659	11.05	92.71	0.02500	0.2033
5	54.7	51.1	81.48	1.065	12.47	93.27	0.02804	0.2025
10	60.2	56.4	80.88	1.172	13.89	93.82	0.03107	0.2018
15	66.2	62.2	80.26	1.287	15.33	94.36	0.03408	0.2011
20	72.6	68.3	79.64	1.412	16.78	94.89	0.03708	0.2005
25	79.4	75.0	79.01	1.545	18.23	95.41	0.04006	0.1998
30	86.7	82.1	78.37	1.689	19.70	95.92	0.04304	0.1992
35	94.6	89.7	77.72	1.843	21.18	96.42	0.04600	0.1986
40	102.9	97.8	77.05	2.008	22.67	96.91	0.04896	0.1980
45	111.8	106.5	76.38	2.186	24.17	97.38	0.05191	0.1974
50	121.2	115.7	75.69	2.376	25.68	97.84	0.05485	0.1968
55	131.2	125.5	74.99	2.580	27.21	98.29	0.05778	0.1963
60	141.9	136.0	74.28	2.798	28.75	98.71	0.06071	0.1957
65	153.1	147.0	73.55	3.032	30.31	99.13	0.06364	0.1952
70	165.0	158.7	72.81	3.283	31.88	99.52	0.06657	0.1946
75	177.6	171.1	72.05	3.552	33.47	99.89	0.06949	0.1940
80	190.8	184.1	71.27	3.840	35.08	100.2	0.07242	0.1935
85	204.8	197.9	70.47	4.149	36.70	100.6	0.07535	0.1929
90	219.5	212.5	69.64	4.482	38.35	100.9	0.07828	0.1923
95	235.0	227.8	68.80	4.839	40.01	101.2	0.08123	0.1917
100	251.3	243.9	67.92	5.224	41.70	101.4	0.08418	0.1911
105	268.4	260.9	67.02	5.638	43.42	101.6	0.08715	0.1904
110	286.3	278.7	66.08	6.086	45.16	101.8	0.09013	0.1898
115	305.2	297.4	65.11	6.572	46.94	101.9	0.09314	0.1891
120	324.9	317.1	64.09	7.099	48.74	102.0	0.09617	0.1883
125	345.6	337.7	63.03	7.674	50.59	102.1	0.09924	0.1875
130	367.3	359.3	61.91	8.303	52.48	102.1	0.1024	0.1866
135	390.0	382.0	60.73	8.996	54.42	102.0	0.1055	0.1856
140	413.7	405.7	59.47	9.764	56.41	101.8	0.1087	0.1846



R-403B

R-403B

Composition: (R-22 / 290 / 218) • (56 / 5 / 39 wt%)

Replaces: R-13B1

Application:

Very low temperature single-stage refrigeration

Performance:

- Evaporator operates in a vacuum when the low side temperature is below -55°F
- Capillary tube must be replaced with a longer/more restrictive size

Lubricant:

Compatible with mineral oil, alkylbenzene and polyolester

Retrofitting:

- Replacement for R-13B1 (Follow equipment manufacturer's guidelines)

[PRESSURE-TEMP CHART]

TEMP. (°F)	R-403B psig
-70	10.5"
-65	7.8"
-60	4.5"
-55	1.2"
-50	1.3
-45	3.3
-40	4.8
-35	7.4
-30	10.1
-25	13.2
-20	16.5
-15	20.1
-10	24.0
-5	28.2
0	32.8
5	37.7
10	43.0
15	48.7
20	54.9
25	61.4
30	68.4
35	75.9
40	84.8
45	93.3
50	102
55	112
60	122
65	132
70	144
75	156
80	168
85	181
90	195
95	210
100	225
105	242
110	258
115	276
120	295

[PHYSICAL PROPERTIES OF REFRIGERANTS]

	National R-403B
Environmental Classification	HCFC
Molecular Weight	103.25
Boiling Point (1atm, °F)	-46.8
Critical Pressure (psia)	637.7
Critical Temperature (°F)	191.6
Critical Density (lb./ft ³)	32.9
Liquid Density (70 °F, lb./ft ³)	72.8
Vapor Density (bp, lb./ft ³)	0.35
Heat of Vaporization (bp, BTU/lb.)	82.1
Specific Heat Liquid (70 °F, BTU/lb. °F)	0.313
Specific Heat Vapor (1atm, 70 °F, BTU/lb. °F)	0.182
Ozone Depletion Potential (CFC 11 = 1.0)	0.028
Global Warming Potential (CO2 = 1.0)	4460
ASHRAE Standard 34 Safety Rating	A1
Temperature Glide (°F) (see section 2)	2

[AVAILABLE IN SIZES]

REFRIGERANT

R-403B

Type	Size
Cylinder	25 lb.
	100 lb.



Thermodynamic Properties of R-403B

TEMP. (°F)	Pressure Liquid (psia)	Pressure Vapor (psia)	Density Liquid (lb/ft ³)	Density Vapor (lb/ft ³)	Enthalpy Liquid (Btu/lb)	Enthalpy Vapor (Btu/lb)	Entropy Liquid (Btu/R-lb)	Entropy Vapor (Btu/R-lb)
-70	9.7	9.4	88.22	—	—	—	—	—
-65	11.0	10.8	87.65	—	—	—	—	—
-60	12.6	12.3	87.07	—	—	—	—	—
-55	14.2	14.0	86.50	—	—	—	—	—
-50	16.1	15.8	85.92	—	—	—	—	—
-45	18.1	17.8	85.35	—	—	—	—	—
-40	20.2	19.5	84.77	0.470	4.23	82.89	0.02197	0.2087
-35	22.8	22.1	84.23	0.527	5.52	83.54	0.02501	0.2080
-30	25.6	24.8	83.69	0.590	6.83	84.18	0.02804	0.2073
-25	28.6	27.9	83.14	0.658	8.14	84.82	0.03105	0.2067
-20	32.0	31.2	82.58	0.731	9.46	85.46	0.03405	0.2062
-15	35.6	34.8	82.02	0.812	10.79	86.08	0.03703	0.2056
-10	39.5	38.7	81.45	0.898	12.13	86.70	0.03999	0.2051
-5	43.8	42.9	80.87	0.992	13.48	87.31	0.04294	0.2046
0	48.4	47.5	80.29	1.094	14.83	87.91	0.04587	0.2042
5	53.3	52.4	79.70	1.203	16.20	88.51	0.04880	0.2037
10	58.6	57.7	79.10	1.321	17.58	89.09	0.05171	0.2033
15	64.4	63.4	78.49	1.448	18.96	89.66	0.05460	0.2029
20	70.5	69.6	77.87	1.584	20.36	90.22	0.05749	0.2025
25	77.1	76.1	77.25	1.730	21.76	90.78	0.06036	0.2021
30	84.1	83.1	76.61	1.888	23.18	91.31	0.06322	0.2018
35	91.6	90.6	75.96	2.056	24.61	91.84	0.06608	0.2014
40	99.5	98.5	75.30	2.237	26.04	92.35	0.06892	0.2011
45	108.0	107.0	74.63	2.431	27.49	92.85	0.07176	0.2007
50	117.0	116.0	73.94	2.638	28.95	93.33	0.07458	0.2004
55	126.6	125.5	73.24	2.860	30.43	93.80	0.07740	0.2000
60	136.7	135.6	72.53	3.098	31.91	94.25	0.08022	0.1997
65	147.4	146.3	71.80	3.352	33.41	94.68	0.09303	0.1993
70	158.7	157.6	71.06	3.624	34.92	95.09	0.08583	0.1990
75	170.6	169.5	70.29	3.915	36.45	95.48	0.08863	0.1986
80	183.2	182.1	69.51	4.227	37.99	95.85	0.09143	0.1982
85	196.4	195.3	68.71	4.560	39.55	96.20	0.09423	0.1978
90	210.4	209.2	67.89	4.918	41.12	96.53	0.09702	0.1974
95	225.0	223.9	67.05	5.301	42.71	96.83	0.09982	0.1970
100	240.4	239.2	66.18	5.711	44.32	97.10	0.1026	0.1966
105	256.5	255.3	65.29	6.153	45.94	97.34	0.1054	0.1961
110	273.4	272.2	64.37	6.627	47.59	97.55	0.1082	0.1956
115	291.0	289.9	63.41	7.138	49.26	97.73	0.1111	0.1951
120	309.5	308.3	62.43	7.689	50.95	97.87	0.1139	0.1946



R-404A

R-404A

Composition: (R-125 / 143a / 134a) • (44 / 52 / 4 wt%)

Replaces: R-502

Application:

Medium and low temperature commercial and industrial refrigeration and ice machines

Performance:

- Similar PT and flow properties to R-502 (same TXV)
- Best used in lower temperature refrigeration

Lubricant:

Polyolester lubricant

Retrofitting:

- Consult the comments on Pages 9 and 10
- See Section II, pages 92-98 for detailed discussion

[PRESSURE-TEMP CHART]

TEMP. (°F)	R-404A psig
-40	4.3
-35	6.8
-30	9.5
-25	12.5
-20	15.7
-15	19.3
-10	23.2
-5	27.5
0	32.1
5	37.0
10	42.4
15	48.2
20	54.5
25	61.2
30	68.4
35	76.1
40	84.4
45	93.2
50	103
55	113
60	123
65	135
70	147
75	159
80	173
85	187
90	202
95	218
100	234
105	252
110	270
115	289
120	310
125	331
130	353
135	377
140	401

[PHYSICAL PROPERTIES OF REFRIGERANTS]

	National R-404A
Environmental Classification	HFC
Molecular Weight	97.6
Boiling Point (1atm, °F)	-51.8
Critical Pressure (psia)	548.2
Critical Temperature (°F)	162.5
Critical Density (lb./ft ³)	35.84
Liquid Density (70 °F, lb./ft ³)	66.37
Vapor Density (bp, lb./ft ³)	0.342
Heat of Vaporization (bp, BTU/lb.)	86.1
Specific Heat Liquid (70 °F, BTU/lb. °F)	0.3600
Specific Heat Vapor (1atm, 70 °F, BTU/lb. °F)	0.2077
Ozone Depletion Potential (CFC 11 = 1.0)	0
Global Warming Potential (CO ₂ = 1.0)	3920
ASHRAE Standard 34 Safety Rating	A1
Temperature Glide (°F) (see section 2)	1.5

[AVAILABLE IN SIZES]

REFRIGERANT	Type	Size
R-404A	Cylinder	24 lb.
		100 lb.
		800 lb.
		1,300 lb.



Thermodynamic Properties of R-404A

TEMP. (°F)	Pressure Liquid (psia)	Pressure Vapor (psia)	Density Liquid (lb/ft ³)	Density Vapor (lb/ft ³)	Enthalpy Liquid (Btu/lb)	Enthalpy Vapor (Btu/lb)	Entropy Liquid (Btu/R-lb)	Entropy Vapor (Btu/R-lb)
-60	11.8	11.3	82.53	0.2671	-5.913	81.19	-0.01439	0.2041
-55	13.5	13.0	82.01	0.3044	-4.447	81.92	-0.01075	0.2032
-50	15.4	14.9	81.48	0.3457	-2.973	82.64	-0.00714	0.2023
-45	17.6	16.9	80.94	0.3913	-1.490	83.36	-0.00356	0.2015
-40	19.9	19.3	80.40	0.4414	0.000	84.08	0.00000	0.2008
-35	22.5	21.8	79.86	0.4965	1.499	84.79	0.00354	0.2001
-30	25.4	24.6	79.31	0.5568	3.007	85.50	0.00705	0.1994
-25	28.5	27.7	78.75	0.6228	4.524	86.20	0.01054	0.1988
-20	31.9	31.0	78.19	0.6947	6.051	86.90	0.01402	0.1982
-15	35.6	34.7	77.62	0.7730	7.587	87.59	0.01747	0.1977
-10	39.7	38.7	77.05	0.8582	9.133	88.28	0.02091	0.1972
-5	44.1	43.0	76.46	0.9506	10.69	88.95	0.02433	0.1967
0	48.8	47.7	75.87	1.051	12.26	89.62	0.02773	0.1963
5	54.0	52.8	75.27	1.159	13.84	90.29	0.03112	0.1959
10	59.5	58.3	74.66	1.276	15.43	90.94	0.03449	0.1955
15	65.5	64.2	74.05	1.403	17.03	91.58	0.03785	0.1951
20	71.9	70.5	73.42	1.539	18.64	92.21	0.04120	0.1948
25	78.7	77.3	72.78	1.686	20.27	92.83	0.04454	0.1945
30	86.1	84.6	72.13	1.845	21.91	93.44	0.04787	0.1941
35	93.9	92.4	71.46	2.016	23.57	94.04	0.05120	0.1938
40	102.3	100.7	70.79	2.200	25.24	94.62	0.05451	0.1935
45	111.2	109.5	70.10	2.397	26.92	95.19	0.05782	0.1932
50	120.7	118.9	69.39	2.610	28.62	95.74	0.06113	0.1930
55	130.7	128.9	68.67	2.839	30.34	96.28	0.06443	0.1927
60	141.4	139.6	67.93	3.086	32.08	96.80	0.06774	0.1924
65	152.8	150.8	67.16	3.352	33.84	97.29	0.07104	0.1921
70	164.7	162.8	66.38	3.638	35.62	97.76	0.07435	0.1918
75	177.4	175.4	65.58	3.947	37.42	98.21	0.07767	0.1915
80	190.8	188.8	64.75	4.281	39.24	98.63	0.08099	0.1911
85	204.9	202.8	63.89	4.642	41.09	99.03	0.08433	0.1908
90	219.9	217.7	62.99	5.033	42.97	99.39	0.08768	0.1904
95	235.6	233.4	62.07	5.458	44.87	99.71	0.09105	0.1900
100	252.1	249.9	61.10	5.921	46.81	100.0	0.09444	0.1895
105	269.5	267.3	60.09	6.426	48.79	100.2	0.09786	0.1890
110	287.8	285.5	59.03	6.981	50.81	100.4	0.1013	0.1884
115	307.0	304.7	57.91	7.592	52.88	100.5	0.1048	0.1878
120	327.2	324.9	56.73	8.271	54.99	100.6	0.1084	0.1870
125	384.4	346.1	55.46	9.029	57.18	100.5	0.1120	0.1862
130	370.6	368.4	54.08	9.886	59.43	100.4	0.1157	0.1852
135	394.0	391.8	52.58	10.87	61.79	100.1	0.1196	0.1840
140	418.5	416.4	50.92	12.01	64.26	99.60	0.1236	0.1825
145	444.3	442.3	49.01	13.39	66.9	98.89	0.1278	0.1807
150	471.4	469.6	46.73	15.13	69.81	97.78	0.1324	0.1783
155	500.0	498.4	43.74	17.55	73.21	95.98	0.1378	0.1748



R-407A

R-407A

Composition: (R-32 / 125 / 134a) • (20 / 40 / 40 wt%)

Replaces: R-22

Application:

Medium and low temperature commercial and industrial refrigeration

Performance:

- Lower discharge temperature
- Closest capacity match to R-22
- Similar P/T and flow properties = no component changes

Lubricant:

Polyolester lubricant

Retrofitting:

- Consult the comments on Pages 9 and 10
- See Section II, pages 92-98 for detailed discussion

[PRESSURE-TEMP CHART]

R407A		
TEMP. (°F)	Liquid (psig)	Vapor (psig)
-40	3.9	1.0"
-35	6.4	1.0
-30	9.2	3.3
-25	12.2	5.8
-20	15.6	8.5
-15	19.2	11.5
-10	23.2	14.9
-5	27.5	18.5
0	32.2	22.5
5	37.3	26.9
10	42.8	31.6
15	48.7	36.7
20	55.1	42.3
25	62.0	48.3
30	69.3	54.8
35	77.2	61.8
40	85.6	69.4
45	94.6	77.4
50	104	86.1
55	114	95.3
60	125	105
65	137	116
70	149	127
75	162	139
80	175	152
85	190	165
90	205	179
95	221	194
100	238	210
105	255	227
110	274	245
115	293	264
120	314	284
125	335	305
130	358	327
135	382	350
140	406	375

[PHYSICAL PROPERTIES OF REFRIGERANTS]

	National R-407A
Environmental Classification	HFC
Molecular Weight	90.1
Boiling Point (1atm, °F)	-49.9
Critical Pressure (psia)	658.6
Critical Temperature (°F)	181
Critical Density (lb./ft ³)	31.4
Liquid Density (70 °F, lb./ft ³)	72.6
Vapor Density (bp, lb./ft ³)	0.291
Heat of Vaporization (bp, BTU/lb.)	100.8
Specific Heat Liquid (70 °F, BTU/lb. °F)	0.3554
Specific Heat Vapor (1atm, 70 °F, BTU/lb. °F)	0.1967
Ozone Depletion Potential (CFC 11 = 1.0)	0
Global Warming Potential (CO ₂ = 1.0)	2110
ASHRAE Standard 34 Safety Rating	A1
Temperature Glide (°F) (see section 2)	10

[AVAILABLE IN SIZES]

REFRIGERANT

R-407A

Type	Size
Cylinder	25 lb.
	100 lb.
	925 lb.
	1,550 lb.



Thermodynamic Properties of R-407A

TEMP. (°F)	Pressure Liquid (psia)	Pressure Vapor (psia)	Density Liquid (lb/ft ³)	Density Vapor (lb/ft ³)	Enthalpy Liquid (Btu/lb)	Enthalpy Vapor (Btu/lb)	Entropy Liquid (Btu/R-lb)	Entropy Vapor (Btu/R-lb)
-60	10.8	7.6	88.81	0.164	-6.1454	95.41	-0.01496	0.2434
-55	12.5	8.9	88.26	0.189	-4.6163	96.12	-0.01117	0.2418
-50	14.3	10.3	87.72	0.218	-3.0826	96.82	-0.00741	0.2404
-45	16.4	11.9	87.17	0.250	-1.5440	97.52	-0.00369	0.2390
-40	18.6	13.7	86.61	0.285	0.000	98.21	0.00000	0.2376
-35	21.1	15.7	86.05	0.325	1.5496	98.90	0.00366	0.2364
-30	23.9	18.0	85.49	0.368	3.1052	99.59	0.00729	0.2351
-25	26.9	20.4	84.92	0.416	4.6672	100.3	0.01088	0.2340
-20	30.3	23.2	84.35	0.469	6.2358	100.9	0.01446	0.2329
-15	33.9	26.2	83.77	0.527	7.8114	101.6	0.01800	0.2319
-10	37.9	29.6	83.18	0.591	9.3945	102.3	0.02152	0.2309
-5	42.2	33.2	82.59	0.660	10.99	102.9	0.02502	0.2299
0	46.9	37.2	81.99	0.736	12.58	103.6	0.02849	0.2290
5	52.0	41.6	81.39	0.818	14.19	104.2	0.03195	0.2281
10	57.5	46.3	80.77	0.908	15.81	104.8	0.03538	0.2273
15	63.4	51.4	80.15	1.005	17.44	105.4	0.03880	0.2264
20	69.8	57.0	79.52	1.111	19.07	106.0	0.04219	0.2257
25	76.7	63.0	78.88	1.225	20.72	106.6	0.04558	0.2249
30	84.0	69.5	78.23	1.349	22.38	107.2	0.04894	0.2242
35	91.9	76.5	77.57	1.482	24.05	107.8	0.05230	0.2235
40	100	84.1	76.90	1.626	25.73	108.3	0.05564	0.2228
45	109	92.1	76.21	1.782	27.42	108.9	0.05897	0.2221
50	119	101	75.52	1.949	29.13	109.4	0.06229	0.2214
55	129	110	74.81	2.130	30.85	109.9	0.06561	0.2208
60	140	120	74.08	2.325	32.59	110.4	0.06892	0.2202
65	151	130	73.34	2.534	34.35	110.9	0.07222	0.2195
70	164	142	72.58	2.760	36.12	111.3	0.07552	0.2189
75	176	154	71.80	3.003	37.91	111.7	0.07882	0.2182
80	190	166	71.01	3.265	39.72	112.1	0.08213	0.2176
85	204	180	70.19	3.548	41.55	112.5	0.08543	0.2169
90	220	194	69.34	3.853	43.40	112.9	0.08874	0.2163
95	236	209	68.48	4.183	45.27	113.2	0.09206	0.2156
100	252	225	67.58	4.539	47.17	113.4	0.09539	0.2148
105	270	242	66.65	4.925	49.10	113.7	0.09874	0.2141
110	289	260	65.69	5.345	51.06	113.9	0.1021	0.2133
115	308	279	64.69	5.801	53.06	114.1	0.1055	0.2125
120	329	299	63.64	6.298	55.09	114.2	0.1089	0.2116
125	350	320	62.55	6.843	57.16	114.2	0.1124	0.2107
130	373	342	61.39	7.443	59.28	114.2	0.1159	0.2097
135	396	365	60.17	8.106	61.45	114.1	0.1194	0.2086
140	421	390	58.87	8.843	63.69	113.9	0.1230	0.2074



R-407C

R-407C

Composition: (R-32 / 125 / 134a) • (23 / 25 / 52 wt%)

Replaces: R-22

Application:

Medium temperature commercial and industrial refrigeration and residential and commercial air conditioning

Performance:

- Lower discharge temperature
- Closest capacity match to R-22
- Similar P/T and flow properties = no component changes

Lubricant:

Polyolester lubricant

Retrofitting:

- Consult the comments on Pages 9 and 10
- See Section II, pages 92-98 for detailed discussion

[PRESSURE-TEMP CHART]

R407C		
TEMP. (°F)	Liquid (psig)	Vapor (psig)
-40	3.0	4.4"
-35	5.4	0.6"
-30	8.0	1.8
-25	10.9	4.1
-20	14.1	6.6
-15	17.6	9.4
-10	21.3	12.5
-5	25.4	15.9
0	29.9	19.6
5	34.7	23.6
10	39.9	28.0
15	45.6	32.8
20	51.6	38.0
25	58.2	43.6
30	65.2	49.6
35	72.6	56.1
40	80.7	63.1
45	89.2	70.6
50	98.3	78.7
55	108	87.3
60	118	96.8
65	129	106
70	141	117
75	153	128
80	166	140
85	180	153
90	195	166
95	210	181
100	226	196
105	243	211
110	261	229
115	280	247
120	300	266
125	321	286
130	342	307
135	365	329
140	389	353

[PHYSICAL PROPERTIES OF REFRIGERANTS]

	National R-407C
Environmental Classification	HFC
Molecular Weight	86.2
Boiling Point (1atm, °F)	-43.6
Critical Pressure (psia)	672.1
Critical Temperature (°F)	187
Critical Density (lb./ft ³)	32
Liquid Density (70°F, lb./ft ³)	72.4
Vapor Density (bp, lb./ft ³)	0.289
Heat of Vaporization (bp, BTU/lb.)	106.7
Specific Heat Liquid (70°F, BTU/lb. °F)	0.3597
Specific Heat Vapor (1atm, 70°F, BTU/lb. °F)	0.1987
Ozone Depletion Potential (CFC 11 = 1.0)	0
Global Warming Potential (CO ₂ = 1.0)	1770
ASHRAE Standard 34 Safety Rating	A1
Temperature Glide (°F) (see section 2)	10

[AVAILABLE IN SIZES]

REFRIGERANT	Type	
	Type	Size
R-407C	Cylinder	25 lb.
		115 lb.
		925 lb.
		1,550 lb.



Thermodynamic Properties of R-407C

TEMP. (°F)	Pressure Liquid (psia)	Pressure Vapor (psia)	Density Liquid (lb/ft ³)	Density Vapor (lb/ft ³)	Enthalpy Liquid (Btu/lb)	Enthalpy Vapor (Btu/lb)	Entropy Liquid (Btu/R-lb)	Entropy Vapor (Btu/R-lb)
-60	10.2	6.9	87.66	0.1418	-6.192	100.9	-0.01508	0.2575
-55	11.8	8.0	87.14	0.1641	-4.653	101.6	-0.01126	0.2558
-50	13.5	9.4	86.61	0.1890	-3.108	102.3	-0.00747	0.2542
-45	15.4	10.8	86.08	0.2169	-1.557	103.0	-0.00372	0.2527
-40	17.6	12.5	85.55	0.2480	0.000	103.7	0.00000	0.2512
-35	19.9	14.3	85.01	0.2825	1.564	104.4	0.00369	0.2498
-30	22.6	16.4	84.46	0.3206	3.134	105.1	0.00735	0.2484
-25	25.4	18.7	83.91	0.3628	4.711	105.8	0.01099	0.2472
-20	28.6	21.2	83.36	0.4092	6.296	106.5	0.01460	0.2459
-15	32.0	24.0	82.80	0.4602	7.888	107.2	0.01818	0.2448
-10	35.8	27.1	82.23	0.5160	9.488	107.9	0.02174	0.2437
-5	39.9	30.5	81.66	0.5771	11.10	108.5	0.02528	0.2426
0	44.3	34.2	81.08	0.6438	12.71	109.2	0.02879	0.2416
5	49.1	38.3	80.50	0.7164	14.34	109.8	0.03229	0.2406
10	54.3	42.7	79.90	0.7954	15.97	110.5	0.03576	0.2396
15	59.9	47.4	79.30	0.8812	17.62	111.1	0.03922	0.2387
20	66.0	52.6	78.70	0.9742	19.27	111.7	0.04265	0.2378
25	72.5	58.3	78.08	1.075	20.94	112.3	0.04608	0.2370
30	79.4	64.3	77.46	1.184	22.62	112.9	0.04948	0.2361
35	86.9	70.9	76.82	1.302	24.30	113.5	0.05288	0.2353
40	94.9	77.9	76.18	1.429	26.00	114.1	0.05626	0.2346
45	103.4	85.4	75.52	1.566	27.72	114.6	0.05963	0.2338
50	112.5	93.5	74.85	1.714	29.44	115.1	0.06298	0.2331
55	122.2	102.2	74.18	1.873	31.18	115.7	0.06633	0.2323
60	132.4	111.5	73.48	2.044	32.94	116.2	0.06968	0.2316
65	143.4	121.4	72.78	2.229	34.71	116.7	0.07301	0.2309
70	154.9	131.9	72.06	2.428	36.49	117.1	0.07635	0.2302
75	167.2	143.1	71.32	2.642	38.30	117.6	0.07968	0.2295
80	180.2	155.1	70.57	2.872	40.12	118.0	0.08301	0.2288
85	193.8	167.7	69.80	3.120	41.96	118.4	0.08634	0.2281
90	208.3	181.2	69.00	3.387	43.82	118.8	0.08967	0.2274
95	223.5	195.4	68.19	3.675	45.71	119.1	0.09301	0.2266
100	239.6	210.5	67.35	3.985	47.62	119.4	0.09636	0.2259
105	256.5	226.5	66.48	4.321	49.55	119.7	0.09972	0.2251
110	274.3	243.4	65.59	4.684	51.52	120.0	0.1031	0.2243
115	292.9	261.2	64.66	5.078	53.51	120.2	0.1065	0.2235
120	312.5	280.0	63.70	5.505	55.54	120.3	0.1099	0.2226
125	333.0	299.9	62.70	5.971	57.60	120.4	0.1133	0.2217
130	354.6	320.8	61.65	6.479	59.71	120.5	0.1168	0.2208
135	377.1	342.9	60.55	7.037	61.86	120.5	0.1203	0.2197
140	400.7	366.1	59.39	7.652	64.06	120.4	0.1239	0.2186



R-408A

R-408A

Composition: (R-125 / 143a / 22) • (7 / 46 / 47 wt%)

Replaces: R-502

Application:

Medium and low temperature commercial and industrial refrigeration

Performance:

- Similar PT properties across the whole operating range of temperatures
- Slightly higher discharge temperature

Lubricant:

Mineral oil, alkylbenzene, and polyolester lubricant

Retrofitting:

- Consult the comments on Pages 9 and 10
- See Section II, pages 92-98 for detailed discussion

[PRESSURE-TEMP CHART]

TEMP. (°F)	R-408A psig
-40	2.8
-35	5.1
-30	7.6
-25	10.4
-20	13.5
-15	16.8
-10	20.4
-5	24.4
0	28.7
5	33.3
10	38.3
15	43.7
20	49.5
25	55.8
30	62.5
35	69.7
40	77.4
45	85.6
50	94.3
55	104
60	114
65	124
70	135
75	147
80	159
85	173
90	186
95	201
100	217
105	233
110	250
115	268
120	287
125	307
130	327
135	349
140	372

[PHYSICAL PROPERTIES OF REFRIGERANTS]

	National R-408A
Environmental Classification	HCFC
Molecular Weight	87
Boiling Point (1atm, °F)	-49.8
Critical Pressure (psia)	641.6
Critical Temperature (°F)	182
Critical Density (lb./ft ³)	30
Liquid Density (70 °F, lb./ft ³)	66.9
Vapor Density (bp, lb./ft ³)	0.303
Heat of Vaporization (bp, BTU/lb.)	96.74
Specific Heat Liquid (70 °F, BTU/lb. °F)	0.3416
Specific Heat Vapor (1atm, 70 °F, BTU/lb. °F)	0.1901
Ozone Depletion Potential (CFC 11 = 1.0)	0.024
Global Warming Potential (CO ₂ = 1.0)	3152
ASHRAE Standard 34 Safety Rating	A1
Temperature Glide (°F) (see section 2)	1

[AVAILABLE IN SIZES]

REFRIGERANT	Type	Size
R-408A	Cylinder	24 lb.
		100 lb.



Thermodynamic Properties of R-408A

TEMP. (°F)	Pressure Liquid (psia)	Pressure Vapor (psia)	Density Liquid (lb/ft ³)	Density Vapor (lb/ft ³)	Enthalpy Liquid (Btu/lb)	Enthalpy Vapor (Btu/lb)	Entropy Liquid (Btu/R-lb)	Entropy Vapor (Btu/R-lb)
-60	11.2	10.9	81.70	0.2288	-5.734	92.47	-0.01396	0.2320
-55	12.8	12.5	81.21	0.2604	-4.311	93.14	-0.01043	0.2306
-50	14.6	14.3	80.72	0.2954	-2.881	93.79	-0.00692	0.2293
-45	16.7	16.3	80.22	0.3339	-1.444	94.45	-0.00345	0.2280
-40	18.9	18.5	79.72	0.3763	0.000	95.10	0.00000	0.2268
-35	21.4	21.0	79.21	0.4228	1.451	95.74	0.00342	0.2257
-30	24.1	23.7	78.70	0.4736	2.910	96.38	0.00682	0.2246
-25	27.1	26.6	78.18	0.5291	4.376	97.01	0.01020	0.2235
-20	30.3	29.8	77.65	0.5896	5.851	97.64	0.01356	0.2225
-15	33.9	33.3	77.13	0.6554	7.334	98.26	0.01689	0.2215
-10	37.7	37.1	76.59	0.7268	8.826	98.87	0.02021	0.2206
-5	41.9	41.3	76.05	0.8042	10.33	99.47	0.02350	0.2197
0	46.4	45.8	75.50	0.8879	11.84	100.1	0.02678	0.2189
5	51.3	50.7	74.95	0.9784	13.36	100.7	0.03005	0.2181
10	56.6	55.9	74.39	1.076	14.89	101.2	0.03329	0.2173
15	62.3	61.5	73.82	1.181	16.43	101.8	0.03653	0.2165
20	68.4	67.6	73.24	1.295	17.98	102.4	0.03975	0.2158
25	74.9	74.1	72.65	1.416	19.54	102.9	0.04295	0.2150
30	81.9	81.1	72.06	1.547	21.12	103.4	0.04615	0.2143
35	89.4	88.5	71.45	1.688	22.71	103.9	0.04934	0.2137
40	97.4	96.5	70.84	1.839	24.31	104.4	0.05251	0.2130
45	105.9	104.9	70.21	2.001	25.92	104.9	0.05568	0.2124
50	115.0	113.9	69.58	2.175	27.55	105.4	0.05885	0.2117
55	124.6	123.5	68.93	2.361	29.19	105.9	0.06200	0.2111
60	134.8	133.7	68.26	2.561	30.85	106.3	0.06516	0.2105
65	145.6	144.5	67.59	2.775	32.52	106.7	0.06831	0.2098
70	157.1	155.9	66.90	3.005	34.22	107.1	0.07146	0.2092
75	169.2	167.9	66.19	3.251	35.93	107.5	0.07461	0.2086
80	181.9	180.7	65.46	3.515	37.66	107.9	0.07776	0.2079
85	195.4	194.1	64.72	3.799	39.41	108.2	0.08092	0.2073
90	209.6	208.3	63.95	4.104	41.18	108.5	0.08409	0.2066
95	224.6	223.2	63.16	4.433	42.98	108.8	0.08726	0.2060
100	240.3	238.9	62.34	4.787	44.80	109.0	0.09045	0.2052
105	256.9	255.5	61.50	5.169	46.65	109.2	0.09365	0.2045
110	274.3	272.8	60.62	5.583	48.53	109.4	0.09688	0.2037
115	292.6	291.1	59.71	6.031	50.45	109.5	0.10001	0.2029
120	311.7	310.2	58.76	6.520	52.40	109.6	0.1034	0.2021
125	331.8	330.3	57.76	7.053	54.40	109.6	0.1067	0.2012
130	352.8	351.3	56.71	7.638	56.44	109.5	0.1101	0.2002
135	374.9	373.3	55.60	8.284	58.54	109.4	0.1135	0.1991
140	398.0	396.4	54.41	9.002	60.71	109.2	0.1170	0.1979



R-409A

R-409A

Composition: (R-22 / 124 / 142b) • (60 / 25 / 15 wt%)

Replaces: R-12 & R-500

Application:

Medium and low temperature commercial and industrial refrigeration and non-centrifugal air conditioning (R-500)

Performance:

- Pressure and system capacity match R-12 when operating at an average evaporator temperature 10°F to 20°F.
- Discharge pressure and temperature are higher than R-12
- Capacity match to R-500 at air conditioning temperatures

Lubricant: Mineral oil, alkylbenzene and polyolester lubricant

Retrofitting:

- Consult the comments on Pages 9 and 10
- See Section II, pages 92-98 for detailed discussion

[PRESSURE-TEMP CHART]

R409A		
TEMP. (°F)	Liquid (psig)	Vapor (psig)
-30	0.2"	9.8"
-25	1.8	7.0"
-20	3.9	3.8"
-15	6.2	0.3"
-10	8.7	1.7
-5	11.4	3.8
0	14.4	6.1
5	17.6	8.6
10	21.1	11.4
15	24.9	14.4
20	29.0	17.6
25	33.4	21.2
30	38.1	25.0
35	43.2	29.2
40	48.6	33.6
45	54.4	38.5
50	60.6	43.6
55	67.2	49.2
60	74.2	55.2
65	81.7	61.5
70	89.6	68.4
75	98.0	75.6
80	107	83.4
85	116	91.6
90	126	100
95	137	110
100	148	120
105	159	130
110	172	141
115	184	153
120	198	165
125	212	178
130	227	192
135	242	207
140	258	222

[PHYSICAL PROPERTIES OF REFRIGERANTS]

	National R-409A
Environmental Classification	HCFC
Molecular Weight	97.4
Boiling Point (1atm, °F)	-31.8
Critical Pressure (psia)	680.7
Critical Temperature (°F)	224.4
Critical Density (lb./ft ³)	31.7
Liquid Density (70 °F, lb./ft ³)	76.1
Vapor Density (bp, lb./ft ³)	0.313
Heat of Vaporization (bp, BTU/lb.)	94.75
Specific Heat Liquid (70 °F, BTU/lb. °F)	0.2908
Specific Heat Vapor (1atm, 70 °F, BTU/lb. °F)	0.1685
Ozone Depletion Potential (CFC 11 = 1.0)	0.047
Global Warming Potential (CO ₂ = 1.0)	1585
ASHRAE Standard 34 Safety Rating	A1
Temperature Glide (°F) (see section 2)	13

[AVAILABLE IN SIZES]

REFRIGERANT	Type	Size
R-409A	Cylinder	30 lb.
		125 lb.



Thermodynamic Properties of R-409A

TEMP. (°F)	Pressure Liquid (psia)	Pressure Vapor (psia)	Density Liquid (lb/ft ³)	Density Vapor (lb/ft ³)	Enthalpy Liquid (Btu/lb)	Enthalpy Vapor (Btu/lb)	Entropy Liquid (Btu/R-lb)	Entropy Vapor (Btu/R-lb)
-40	11.9	8.0	87.87	0.1779	0.000	94.00	0.00000	0.2287
-35	13.6	9.3	87.38	0.2030	1.295	94.64	0.00306	0.2274
-30	15.4	10.6	86.90	0.2308	2.594	95.28	0.00609	0.2262
-25	17.4	12.1	86.41	0.2616	3.899	95.92	0.00910	0.2250
-20	19.5	13.8	85.92	0.2954	5.209	96.55	0.01209	0.2239
-15	21.9	15.7	85.42	0.3326	6.524	97.18	0.01505	0.2229
-10	24.6	17.7	84.92	0.3734	7.846	97.81	0.01799	0.2219
-5	27.4	20.0	84.41	0.4180	9.174	98.43	0.02092	0.2209
0	30.5	22.5	83.90	0.4666	10.51	99.05	0.02382	0.2200
5	33.9	25.2	83.38	0.5196	11.85	99.67	0.02670	0.2191
10	37.5	28.2	82.86	0.5771	13.20	100.3	0.02957	0.2182
15	41.5	31.4	82.34	0.6395	14.55	100.9	0.03242	0.2174
20	45.7	34.9	81.80	0.7070	15.91	101.5	0.03525	0.2167
25	50.3	38.7	81.26	0.7800	17.28	102.1	0.03807	0.2159
30	55.2	42.8	80.72	0.8588	18.66	102.6	0.04088	0.2152
35	60.5	47.3	80.17	0.9437	20.05	103.2	0.04367	0.2145
40	66.1	52.0	79.61	1.035	21.44	103.8	0.04645	0.2139
45	72.1	57.2	79.04	1.133	22.84	104.4	0.04921	0.2132
50	78.5	62.7	78.47	1.239	24.25	104.9	0.05197	0.2126
55	85.4	68.6	77.89	1.352	25.67	105.5	0.05471	0.2120
60	92.6	74.9	77.30	1.473	27.11	106.0	0.05744	0.2115
65	100.3	81.7	76.70	1.603	28.55	106.5	0.06017	0.2109
70	108.5	88.9	76.09	1.742	30.00	107.0	0.06288	0.2104
75	117.2	96.6	75.48	1.891	31.46	107.5	0.06559	0.2099
80	126.3	104.8	74.85	2.050	32.93	108.0	0.06829	0.2093
85	136.0	113.4	74.21	2.219	34.42	108.5	0.07089	0.2088
90	146.2	122.7	73.56	2.401	35.92	109.0	0.07367	0.2083
95	157.0	132.4	72.90	2.594	37.43	109.4	0.07636	0.2078
100	168.3	142.7	72.22	2.801	38.95	109.9	0.07904	0.2074
105	180.2	153.7	71.54	3.022	40.49	110.3	0.08172	0.2069
110	192.7	165.2	70.83	3.258	42.04	110.7	0.08440	0.2064
115	205.9	177.4	70.11	3.510	43.61	111.1	0.08708	0.2059
120	219.6	190.2	69.38	3.779	45.19	111.4	0.08977	0.2054
125	234.1	203.7	68.62	4.068	46.80	111.8	0.09245	0.2049
130	249.2	217.9	67.85	4.376	48.42	112.1	0.09515	0.2043
135	265.0	232.9	67.05	4.707	50.06	112.4	0.09785	0.2038
140	281.5	248.6	66.22	5.062	51.72	112.6	0.1006	0.2033
145	298.8	265.1	65.38	5.443	53.41	112.9	0.1033	0.2027
150	316.8	282.5	64.50	5.853	55.13	113.1	0.1060	0.2021
155	335.6	300.7	63.58	6.296	56.87	113.2	0.1088	0.2014
160	355.2	319.8	62.63	6.775	58.65	113.4	0.1116	0.2008



R-410A

R-410A

Composition: (R-32 / 125) • (50 / 50 wt%)

Application:

Air conditioning equipment and heat pumps. Only for newly manufactured equipment, NOT for retrofitting R-22

Performance:

- Pressures are 60% higher than R-22, therefore should be used only in new equipment.

Lubricant:

Polyolester lubricant

Retrofitting:

- For new equipment only

[PRESSURE-TEMP CHART]

TEMP. (°F)	R-410A psig
-40	11.6
-35	14.9
-30	18.5
-25	22.5
-20	26.9
-15	31.7
-10	36.8
-5	42.5
0	48.6
5	55.2
10	62.3
15	70.0
20	78.3
25	87.3
30	96.8
35	107
40	118
45	130
50	142
55	155
60	170
65	185
70	201
75	217
80	235
85	254
90	274
95	295
100	317
105	340
110	365
115	391
120	418
125	446
130	476
135	507
140	539
145	573
150	608

[PHYSICAL PROPERTIES OF REFRIGERANTS]

	National R-410A
Environmental Classification	HFC
Molecular Weight	72.6
Boiling Point (1atm, °F)	-61
Critical Pressure (psia)	691.8
Critical Temperature (°F)	158.3
Critical Density (lb./ft ³)	34.5
Liquid Density (70 °F, lb./ft ³)	67.74
Vapor Density (bp, lb./ft ³)	0.261
Heat of Vaporization (bp, BTU/lb.)	116.8
Specific Heat Liquid (70 °F, BTU/lb. °F)	0.3948
Specific Heat Vapor (1atm, 70 °F, BTU/lb. °F)	0.1953
Ozone Depletion Potential (CFC 11 = 1.0)	0
Global Warming Potential (CO ₂ = 1.0)	2088
ASHRAE Standard 34 Safety Rating	A1
Temperature Glide (°F) (see section 2)	0.2

[AVAILABLE IN SIZES]

REFRIGERANT	Type	Size
R-410A	Cylinder	25 lb.
		100 lb.
		850 lb.
		1,450 lb.



Thermodynamic Properties of R-410A

TEMP. (°F)	Pressure Liquid (psia)	Pressure Vapor (psia)	Density Liquid (lb/ft ³)	Density Vapor (lb/ft ³)	Enthalpy Liquid (Btu/lb)	Enthalpy Vapor (Btu/lb)	Entropy Liquid (Btu/R-lb)	Entropy Vapor (Btu/R-lb)
-40	25.6	25.5	82.02	0.4384	0.000	112.5	0.00000	0.2682
-35	28.9	28.9	81.45	0.4929	1.648	113.1	0.00389	0.2664
-30	32.6	32.6	80.88	0.5526	3.303	113.7	0.00774	0.2647
-25	36.7	36.6	80.30	0.6179	4.967	114.3	0.01157	0.2631
-20	41.1	41.0	79.71	0.6892	6.640	114.8	0.01537	0.2615
-15	46.0	45.8	79.12	0.7669	8.321	115.4	0.01915	0.2599
-10	51.2	51.1	78.51	0.8514	10.01	115.9	0.02290	0.2584
-5	56.9	56.8	77.91	0.9431	11.71	116.4	0.02663	0.2570
0	63.1	63.0	77.29	1.043	13.42	116.9	0.03035	0.2555
5	69.8	69.7	76.66	1.151	15.15	117.4	0.03404	0.2541
10	77.1	76.9	76.03	1.267	16.88	117.9	0.03771	0.2528
15	84.9	84.6	75.38	1.394	18.63	118.3	0.04137	0.2514
20	93.2	93.0	74.73	1.530	20.39	118.8	0.04502	0.2501
25	102.2	101.9	74.06	1.677	22.16	119.2	0.04865	0.2488
30	111.9	111.5	73.38	1.836	23.95	119.6	0.05227	0.2476
35	122.2	121.8	72.69	2.007	25.75	119.9	0.05588	0.2463
40	133.2	132.8	71.99	2.192	27.58	120.3	0.05949	0.2451
45	144.9	144.5	71.27	2.391	29.41	120.6	0.06309	0.2438
50	157.4	156.9	70.53	2.606	31.27	120.9	0.06668	0.2426
55	170.7	170.2	69.78	2.838	33.14	121.2	0.07028	0.2413
60	184.8	184.3	69.01	3.088	35.04	121.4	0.07387	0.2401
65	199.8	199.2	68.22	3.357	36.96	121.6	0.07747	0.2388
70	215.7	215.1	67.41	3.648	38.90	121.8	0.08107	0.2376
75	232.5	231.8	66.58	3.963	40.87	121.9	0.08469	0.2363
80	250.3	249.6	65.71	4.304	42.87	122.0	0.08832	0.2350
85	269.1	268.3	64.82	4.674	44.90	122.0	0.09196	0.2336
90	289.0	288.2	63.90	5.075	46.96	122.0	0.09562	0.2322
95	310.0	309.1	62.95	5.513	49.06	122.0	0.09932	0.2308
100	332.0	331.1	61.95	5.990	51.21	121.8	0.1030	0.2293
105	355.3	354.3	60.90	6.513	53.39	121.6	0.1068	0.2277
110	379.8	378.8	59.81	7.089	55.63	121.4	0.1106	0.2261
115	405.6	404.5	58.65	7.725	57.93	121.0	0.1145	0.2243
120	432.7	431.6	57.42	8.434	60.30	120.5	0.1185	0.2224
125	461.2	460.1	56.11	9.230	62.76	119.9	0.1225	0.2203
130	491.2	490.1	54.68	10.13	65.31	119.2	0.1267	0.2180
135	522.7	521.6	53.12	11.17	67.99	118.2	0.1310	0.2155
140	555.9	554.8	51.38	12.40	70.84	117.0	0.1356	0.2125



R-414B

R-414B

Composition: (R-22 / 600a / 124 / 142b) • (50 / 1.5 / 39 / 9.5 wt%)

Replaces: R-12 & R-500

Application:

Medium and low temperature commercial and industrial refrigeration and stationary and automotive air conditioning

Performance:

- Pressure and capacity match R-12 in 30°F to 40°F evaporators
- Slightly higher discharge pressure compared to R-12
- Approved for retrofitting automotive AC

Lubricant:

Mineral oil, alkylbenzene, and polyolester lubricant

Retrofitting:

- Consult the comments on Pages 9 and 10
- See Section II, pages 92-98 for detailed discussion

[PRESSURE-TEMP CHART]

R414B		
TEMP. (°F)	Liquid (psig)	Vapor (psig)
-30	2.0"	11.3"
-25	0.8	8.6"
-20	2.8	5.6"
-15	4.9	2.3"
-10	7.3	0.7
-5	9.9	2.7
0	12.7	4.9
5	15.7	7.3
10	19.0	9.9
15	22.6	12.8
20	26.4	15.9
25	30.6	19.2
30	35.0	22.9
35	39.8	26.9
40	44.9	31.1
45	50.4	35.7
50	56.2	40.7
55	62.4	46.0
60	69.0	51.6
65	76.0	57.7
70	83.5	64.2
75	91.4	71.1
80	99.7	78.4
85	109	86.2
90	118	94.5
95	128	103
100	138	113
105	149	122
110	160	133
115	172	144
120	185	156
125	198	168
130	212	181
135	227	194
140	242	208

[PHYSICAL PROPERTIES OF REFRIGERANTS]

	National R-414B
Environmental Classification	HCFC
Molecular Weight	101.6
Boiling Point (1atm, °F)	-29.9
Critical Pressure (psia)	665.4
Critical Temperature (°F)	226.4
Critical Density (lb./ft ³)	31.6
Liquid Density (70 °F, lb./ft ³)	76.02
Vapor Density (bp, lb./ft ³)	0.325
Heat of Vaporization (bp, BTU/lb.)	91.5
Specific Heat Liquid (70 °F, BTU/lb. °F)	0.2913
Specific Heat Vapor (1atm, 70 °F, BTU/lb. °F)	0.1723
Ozone Depletion Potential (CFC 11 = 1.0)	0.043
Global Warming Potential (CO ₂ = 1.0)	1365
ASHRAE Standard 34 Safety Rating	A1
Temperature Glide (°F) (see section 2)	13

[AVAILABLE IN SIZES]

REFRIGERANT	Type	Size
R-414B	Cylinder	25 lb.



Thermodynamic Properties of R-414B

TEMP. (°F)	Pressure Liquid (psia)	Pressure Vapor (psia)	Density Liquid (lb/ft ³)	Density Vapor (lb/ft ³)	Enthalpy Liquid (Btu/lb)	Enthalpy Vapor (Btu/lb)	Entropy Liquid (Btu/R-lb)	Entropy Vapor (Btu/R-lb)
-40	10.61	6.87	88.21	0.1584	0.000	92.16	0.00000	0.2241
-35	12.08	7.94	87.73	0.1811	1.301	92.82	0.00308	0.2230
-30	13.70	9.13	87.25	0.2064	2.608	93.49	0.00612	0.2219
-25	15.49	10.45	86.77	0.2343	3.919	94.15	0.00915	0.2208
-20	17.46	11.93	86.28	0.2652	5.235	94.81	0.01215	0.2198
-15	19.62	13.57	85.79	0.2991	6.557	95.47	0.01513	0.2189
-10	21.98	15.38	85.29	0.3363	7.884	96.13	0.01809	0.2180
-5	24.56	17.37	84.80	0.3771	9.217	96.78	0.02102	0.2171
0	27.37	19.56	84.29	0.4216	10.56	97.43	0.02394	0.2163
5	30.41	21.96	83.78	0.4701	11.90	98.08	0.02684	0.2156
10	33.71	24.59	83.27	0.5228	13.25	98.72	0.02971	0.2149
15	37.28	27.45	82.75	0.5801	14.61	99.36	0.03258	0.2142
20	41.12	30.56	82.23	0.6422	15.98	99.99	0.03542	0.2135
25	45.26	33.94	81.70	0.7093	17.35	100.6	0.03825	0.2129
30	49.72	37.60	81.17	0.7818	18.73	101.2	0.04106	0.2123
35	54.49	41.56	80.63	0.8599	20.12	101.9	0.04386	0.2117
40	59.60	45.83	80.08	0.9441	21.51	102.5	0.04664	0.2112
45	65.07	50.42	79.53	1.035	22.92	103.1	0.04941	0.2107
50	70.90	55.36	78.97	1.132	24.33	103.7	0.05217	0.2102
55	77.11	60.65	78.40	1.236	25.75	104.3	0.05491	0.2097
60	83.72	66.33	77.82	1.348	27.18	104.8	0.05765	0.2093
65	90.74	72.39	77.24	1.468	28.62	105.4	0.06037	0.2089
70	98.20	78.87	76.65	1.596	30.07	106.0	0.06309	0.2084
75	106.1	85.77	76.05	1.733	31.53	106.5	0.06580	0.2080
80	114.4	93.12	75.44	1.880	33.00	107.1	0.06849	0.2076
85	123.3	100.9	74.82	2.036	34.48	107.6	0.07118	0.2073
90	132.6	109.2	74.19	2.204	35.97	108.1	0.07387	0.2069
95	142.4	118.0	73.55	2.382	37.48	108.6	0.07655	0.2065
100	152.8	127.3	72.89	2.572	38.99	109.1	0.07922	0.2062
105	163.7	137.2	72.23	2.776	40.52	109.6	0.08190	0.2058
110	175.1	147.6	71.55	2.993	42.07	110.1	0.08456	0.2054
115	187.1	158.6	70.85	3.224	43.62	110.5	0.08723	0.2051
120	199.7	170.2	70.15	3.472	45.20	111.0	0.08990	0.2047
125	212.9	182.5	69.42	3.736	46.79	111.4	0.09257	0.2044
130	226.8	195.3	68.67	4.018	48.39	111.8	0.09524	0.2040
135	241.3	208.9	67.91	4.320	50.02	112.1	0.09792	0.2036
140	256.4	223.1	67.12	4.644	51.66	112.5	0.1006	0.2032
145	272.2	238.1	66.31	4.990	53.33	112.8	0.1033	0.2028
150	288.7	253.8	65.48	5.363	55.02	113.1	0.1060	0.2023
155	306.0	270.3	64.61	5.763	56.73	113.4	0.1087	0.2019
160	323.9	287.6	63.71	6.195	58.47	113.6	0.1115	0.2014



R-417C

R-417C

Composition: (R-125 / 134a / 600) • (19.5 / 78.8 / 1.7 wt%)

Replaces: R-12 and HCFC-based R-12 retrofit blends

Application:

Medium and low temperature refrigeration

Performance:

- Capacity will be slightly higher than R-12; pressures will run higher than R-12 and similar to R-401A/B and R-409A

Lubricant:

Polyester lubricant; a hydrocarbon additive is designed to circulate mineral oil or alkylbenzene, but addition of POE may be required if there is a problem with circulation.

Retrofitting:

- Consult the comments on Pages 9 and 10
- See Section II, pages 92-98 for detailed discussion

[PRESSURE-TEMP CHART]

R417C		
TEMP. (°F)	Liquid (psig)	Vapor (psig)
-40	8.8"	12.4"
-35	5.9"	9.8"
-30	2.5"	6.7"
-25	0.6	3.5"
-20	2.7	0.2
-15	4.9	2.2
-10	7.3	4.4
-5	10.0	6.9
0	13.0	9.5
5	16.1	12.5
10	19.6	15.7
15	23.4	19.2
20	27.5	23.0
25	31.9	27.2
30	36.6	31.7
35	41.8	36.5
40	47.3	41.7
45	53.2	47.3
50	59.5	53.3
55	66.2	59.8
60	73.4	66.7
65	81.1	74.1
70	89.3	82.0
75	98.0	90.4
80	107	99.3
85	117	109
90	127	119
95	138	130
100	150	141
105	162	153
110	175	166
115	189	179
120	203	193
125	218	208
130	234	223
135	250	240
140	268	257
145	286	275
150	305	294

[PHYSICAL PROPERTIES OF REFRIGERANTS]

	National R-417C
Environmental Classification	HCFC
Molecular Weight	103.7
Boiling Point (1atm, °F)	-26.7
Critical Pressure (psia)	591
Critical Temperature (°F)	204
Critical Density (lb./ft ³)	32.12
Liquid Density (70 °F, lb./ft ³)	74.6
Vapor Density (bp, lb./ft ³)	0.2893
Heat of Vaporization (bp, BTU/lb.)	91.2
Specific Heat Liquid (70 °F, BTU/lb. °F)	0.3387
Specific Heat Vapor (1atm, 70 °F, BTU/lb. °F)	0.2030
Ozone Depletion Potential (CFC 11 = 1.0)	0
Global Warming Potential (CO ₂ = 1.0)	1820
ASHRAE Standard 34 Safety Rating	A1
Temperature Glide (°F) (see section 2)	6

[AVAILABLE IN SIZES]

REFRIGERANT	Type	Size
R-417C	Cylinder	25 lb.



Thermodynamic Properties of R-417C

TEMP. (°F)	Pressure Liquid (psia)	Pressure Vapor (psia)	Density Liquid (lb/ft ³)	Density Vapor (lb/ft ³)	Enthalpy Liquid (Btu/lb)	Enthalpy Vapor (Btu/lb)	Entropy Liquid (Btu/R-lb)	Entropy Vapor (Btu/R-lb)
-60	5.81	4.66	89.34	0.1150	-5.966	89.23	-0.01454	0.2253
-55	6.76	5.47	88.83	0.1336	-4.481	90.00	-0.01086	0.2242
-50	7.82	6.39	88.32	0.1545	-2.993	90.76	-0.00720	0.2232
-45	9.01	7.43	87.81	0.1779	-1.499	91.52	-0.00359	0.2222
-40	10.4	8.60	87.30	0.2041	0.000	92.28	0.00000	0.2213
-35	11.8	9.92	86.78	0.2333	1.504	93.03	0.00356	0.2204
-30	13.5	11.4	86.26	0.2657	3.014	93.79	0.00708	0.2196
-25	15.3	13.0	85.74	0.3016	4.530	94.54	0.01058	0.2189
-20	17.4	14.9	85.21	0.3412	6.052	95.29	0.01405	0.2182
-15	19.6	16.9	84.68	0.3847	7.580	96.04	0.01750	0.2176
-10	22.0	19.1	84.14	0.4326	9.115	96.78	0.02092	0.2170
-5	24.7	21.6	83.60	0.4851	10.66	97.52	0.02432	0.2164
0	27.7	24.2	83.05	0.5424	12.21	98.26	0.02769	0.2159
5	30.8	27.2	82.49	0.6050	13.76	98.99	0.03104	0.2154
10	34.3	30.4	81.93	0.6731	15.33	99.71	0.03438	0.2150
15	38.1	33.9	81.37	0.7472	16.90	100.4	0.03769	0.2146
20	42.2	37.7	80.80	0.8276	18.48	101.1	0.04098	0.2142
25	46.6	41.9	80.22	0.9148	20.07	101.9	0.04426	0.2138
30	51.3	46.4	79.63	1.009	21.67	102.6	0.04752	0.2135
35	56.5	51.2	79.03	1.111	23.28	103.2	0.05076	0.2132
40	62.0	56.4	78.43	1.221	24.90	103.9	0.05399	0.2129
45	67.9	62.0	77.82	1.340	26.53	104.6	0.05721	0.2126
50	74.2	68.0	77.20	1.468	28.17	105.3	0.06041	0.2123
55	80.9	74.5	76.57	1.605	29.82	105.9	0.06360	0.2121
60	88.1	81.4	75.92	1.753	31.48	106.6	0.06678	0.2118
65	95.8	88.8	75.27	1.912	33.15	107.2	0.06995	0.2116
70	104	96.7	74.61	2.083	34.84	107.8	0.07311	0.2114
75	113	105	73.93	2.267	36.54	108.4	0.07627	0.2112
80	122	114	73.23	2.464	38.26	109.0	0.07942	0.2110
85	132	124	72.53	2.676	39.99	109.6	0.08256	0.2108
90	142	134	71.80	2.904	41.73	110.1	0.08570	0.2106
95	153	144	71.06	3.149	43.49	110.7	0.08884	0.2104
100	165	156	70.30	3.411	45.27	111.2	0.09198	0.2102
105	177	168	69.52	3.694	47.07	111.7	0.09513	0.2099
110	190	180	68.72	3.998	48.89	112.2	0.09827	0.2097
115	203	194	67.89	4.326	50.73	112.6	0.1014	0.2094
120	218	208	67.04	4.679	52.60	113.0	0.1046	0.2091
125	233	222	66.16	5.061	54.49	113.4	0.1078	0.2088
130	248	238	65.24	5.474	56.40	113.8	0.1110	0.2085
135	265	255	64.29	5.923	58.35	114.1	0.1142	0.2081
140	282	272	63.30	6.411	60.33	114.3	0.1174	0.2077
145	301	290	62.26	6.943	62.35	114.6	0.1207	0.2072
150	320	309	61.17	7.527	64.41	114.7	0.1240	0.2067
155	340	329	60.02	8.170	66.51	114.8	0.1273	0.2061



R-422C

R-422C

Composition: (R-125 / 134a / 600a) • (82 / 15 / 3 wt%)

Replaces: R-502, R-404A, R-507, or R-22

Application:

Medium temperature commercial and industrial refrigeration

Performance:

- Lower discharge temperature
- TXV may appear undersized when retrofitting R-22 equipment
- Up to 10% lower capacity

Lubricant:

Polyolester lubricant; a hydrocarbon additive is designed to circulate mineral oil or alkylbenzene, but addition of POE may be required if there is a problem with circulation.

Retrofitting:

- Consult the comments on Pages 9 and 10
- See Section II, pages 92-98 for detailed discussion

[PRESSURE-TEMP CHART]

R422C		
TEMP. (°F)	Liquid (psig)	Vapor (psig)
-40	4.7	2.2
-35	7.2	4.5
-30	10.1	7.1
-25	13.1	10.0
-20	16.5	13.2
-15	20.2	16.6
-10	24.2	20.4
-5	28.6	24.5
0	33.3	29.0
5	38.4	33.8
10	43.9	39.1
15	49.8	44.7
20	56.1	50.8
25	63.0	57.4
30	70.3	64.4
35	78.1	72.0
40	86.4	80.1
45	95.3	88.7
50	105	97.9
55	115	108
60	125	118
65	137	129
70	149	141
75	161	153
80	175	167
85	189	181
90	204	195
95	219	211
100	236	227
105	253	244
110	272	263
115	291	282
120	311	302
125	332	323
130	354	345
135	377	369
140	402	394

[PHYSICAL PROPERTIES OF REFRIGERANTS]

	National R-422C
Environmental Classification	HFC
Molecular Weight	113.5
Boiling Point (1atm, °F)	-50.7
Critical Pressure (psia)	547.7
Critical Temperature (°F)	163.5
Critical Density (lb./ft ³)	33.7
Liquid Density (70 °F, lb./ft ³)	72.5
Vapor Density (bp, lb./ft ³)	0.391
Heat of Vaporization (bp, BTU/lb.)	77.0
Specific Heat Liquid (70 °F, BTU/lb. °F)	0.3373
Specific Heat Vapor (1atm, 70 °F, BTU/lb. °F)	0.1973
Ozone Depletion Potential (CFC 11 = 1.0)	0
Global Warming Potential (CO ₂ = 1.0)	3085
ASHRAE Standard 34 Safety Rating	A1
Temperature Glide (°F) (see section 2)	5

[AVAILABLE IN SIZES]

REFRIGERANT

R-422C

Type	Size
Cylinder	24 lb.
	100 lb.



Thermodynamic Properties of R-422C

TEMP. (°F)	Pressure Liquid (psia)	Pressure Vapor (psia)	Density Liquid (lb/ft ³)	Density Vapor (lb/ft ³)	Enthalpy Liquid (Btu/lb)	Enthalpy Vapor (Btu/lb)	Entropy Liquid (Btu/R-lb)	Entropy Vapor (Btu/R-lb)
-60	11.4	9.6	90.27	0.26	-5.616	71.83	-0.01367	0.1819
-55	13.1	11.1	89.70	0.30	-4.222	72.55	-0.01021	0.1812
-50	15.0	12.8	89.12	0.34	-2.822	73.27	-0.00678	0.1805
-45	17.1	14.8	88.54	0.39	-1.414	73.98	-0.00338	0.1800
-40	19.4	16.9	87.95	0.45	0.000	74.70	0.00000	0.1794
-35	21.9	19.2	87.36	0.50	1.422	75.41	0.00335	0.1789
-30	24.7	21.8	86.76	0.57	2.851	76.11	0.00669	0.1785
-25	27.8	24.7	86.16	0.64	4.287	76.82	0.01000	0.1781
-20	31.2	27.9	85.54	0.72	5.732	77.51	0.01328	0.1777
-15	34.9	31.3	84.92	0.80	7.185	78.21	0.01655	0.1773
-10	38.9	35.1	84.30	0.89	8.647	78.90	0.01980	0.1770
-5	43.3	39.2	83.66	0.99	10.12	79.58	0.02303	0.1768
0	48.0	43.7	83.02	1.10	11.60	80.25	0.02625	0.1765
5	53.1	48.5	82.36	1.22	13.09	80.92	0.02945	0.1763
10	58.6	53.8	81.70	1.35	14.59	81.59	0.03263	0.1761
15	64.5	59.4	81.03	1.49	16.10	82.24	0.03580	0.1759
20	70.8	65.5	80.34	1.64	17.62	82.88	0.03896	0.1757
25	77.6	72.1	79.64	1.80	19.15	83.52	0.04210	0.1756
30	84.9	79.1	78.93	1.98	20.70	84.14	0.04524	0.1754
35	92.8	86.7	78.21	2.16	22.25	84.76	0.04837	0.1753
40	101	94.8	77.47	2.37	23.82	85.36	0.05148	0.1752
45	110	103	76.72	2.59	25.41	85.94	0.05460	0.1751
50	119	113	75.95	2.82	27.01	86.52	0.05770	0.1750
55	129	122	75.16	3.08	28.62	87.07	0.06081	0.1748
60	140	133	74.35	3.35	30.25	87.61	0.06391	0.1747
65	151	144	73.52	3.65	31.90	88.13	0.06701	0.1746
70	163	156	72.66	3.97	33.56	88.62	0.07011	0.1745
75	176	168	71.78	4.31	35.25	89.10	0.07322	0.1743
80	189	181	70.87	4.69	36.96	89.54	0.07633	0.1741
85	204	195	69.93	5.09	38.69	89.96	0.07945	0.1739
90	218	210	68.96	5.53	40.44	90.35	0.08258	0.1737
95	234	225	67.95	6.01	42.22	90.70	0.08573	0.1734
100	251	242	66.89	6.53	44.03	91.02	0.08890	0.1731
105	268	259	65.78	7.09	45.88	91.29	0.09210	0.1728
110	286	277	64.62	7.72	47.76	91.52	0.09532	0.1724
115	305	296	63.39	8.41	49.68	91.69	0.09859	0.1719
120	326	317	62.09	9.17	51.65	91.79	0.1019	0.1713
125	347	338	60.69	10.02	53.68	91.82	0.1053	0.1707
130	369	360	59.17	10.99	55.78	91.75	0.1087	0.1699
135	392	384	57.52	12.09	57.97	91.55	0.1123	0.1689
140	416	408	55.67	13.38	60.27	91.20	0.1160	0.1677
145	442	434	53.54	14.94	62.72	90.63	0.1199	0.1662
150	469	462	51.00	16.90	65.41	89.72	0.1242	0.1642



R-422B and R-422D

R-422B R-422D

Composition:

R-422B: (R-125 / 134a / 600a) • (55 / 42 / 3 wt%)

R-422D: (R-125 / 134a / 600a) • (65.1 / 31.5 / 3.4 wt%)

Replaces: R-22

Application:

R-422B: Medium temperature commercial and industrial refrigeration and air conditioning

R-422D: Medium and low temperature commercial and industrial refrigeration and air conditioning

Performance:

- **R-422B:** Best match at warmer evaporator temps / AC
- **R-422D:** Best match at medium temp evaporator / refrigeration
- Lower discharge temperature
- Possible undersized TXV or distributor nozzle based on pressure drop
- Up to 10% lower capacity at lower evaporator temperatures

Lubricant:

Polyolester lubricant; a hydrocarbon additive is designed to circulate mineral oil or alkylbenzene, but addition of POE may be required if there is a problem with circulation.

Retrofitting:

- Consult the comments on Pages 9 and 10
- See Section II, pages 92-96 for detailed discussion

[PHYSICAL PROPERTIES OF REFRIGERANTS]	National R-422B	National R-422D
Environmental Classification	HFC	HFC
Molecular Weight	108.5	109.9
Boiling Point (1atm, °F)	-42.4	-45.8
Critical Pressure (psia)181.8	574.1	566.2
Critical Temperature (°F)73.05	181.8	175.2
Critical Density (lb./ft ³)84.2	32.9	33.0
Liquid Density (70 °F, lb./ft ³)0.201	73.05	70.9
Vapor Density (bp.lb./ft ³)2525	0.363	0.372
Heat of Vaporization (bp, BTU/lb.)5	84.2	81.8
Specific Heat Liquid (70 °F, BTU/lb. °F)	0.3385	0.339
Specific Heat Vapor (1atm, 70 °F, BTU/lb. °F)	0.201	0.20
Ozone Depletion Potential (CFC 11 = 1.0)	0	0
Global Warming Potential (CO2 = 1.0)	2525	2730
ASHRAE Standard 34 Safety Rating	A1	A1
Temperature Glide (°F) (see section 2)	5	5

[PRESSURE-TEMP CHART]

R422B			R422D	
Liquid (psig)	Vapor (psig)	TEMP. (°F)	Liquid (psig)	Vapor (psig)
0.9	2.7"	-40	2.4	2.3"
3.0	0.9"	-35	4.6	0.8
5.4	1.1	-30	7.1	3.0
7.9	3.2	-25	9.9	5.4
10.7	5.7	-20	12.9	8.1
13.8	8.3	-15	16.2	11.0
17.1	11.3	-10	19.8	14.3
20.7	14.5	-5	23.7	17.8
24.7	18.0	0	27.9	21.7
29.0	21.9	5	32.5	25.8
33.6	26.1	10	37.5	30.4
38.6	30.6	15	42.8	35.3
43.9	35.5	20	48.5	40.7
49.7	40.8	25	54.7	46.4
55.9	46.6	30	61.3	52.6
62.5	52.7	35	68.4	59.3
69.6	59.4	40	75.9	66.4
77.2	66.5	45	84.0	74.0
85.3	74.1	50	92.6	82.2
94	82.2	55	102	90.9
103	90.9	60	111	100
113	100	65	122	110
123	110	70	133	121
134	120	75	144	132
145	132	80	156	144
158	143	85	169	156
170	156	90	183	170
184	169	95	197	184
198	183	100	212	198
213	198	105	228	214
229	213	110	245	231
246	230	115	262	248
263	247	120	281	266
281	265	125	300	286
301	284	130	320	306
321	304	135	341	327
342	326	140	364	350

[AVAILABLE IN SIZES]

REFRIGERANT	Type	Size
R-422B	Cylinder	25 lb.
		110 lb.
R-422D	Cylinder	25 lb.
		110 lb.



Thermodynamic Properties of R-422B

TEMP. (°F)	Pressure Liquid (psia)	Pressure Vapor (psia)	Density Liquid (lb/ft ³)	Density Vapor (lb/ft ³)	Enthalpy Liquid (Btu/lb)	Enthalpy Vapor (Btu/lb)	Entropy Liquid (Btu/R-lb)	Entropy Vapor (Btu/R-lb)
-60	9.1	6.6	89.17	0.17	-5.810	79.45	-0.01415	0.2022
-55	10.5	7.7	88.63	0.20	-4.366	80.19	-0.01057	0.2013
-50	12.0	9.0	88.09	0.23	-2.916	80.94	-0.00701	0.2004
-45	13.7	10.4	87.54	0.26	-1.461	81.68	-0.00349	0.1996
-40	15.6	12.0	86.99	0.30	0.000	82.42	0.00000	0.1989
-35	17.7	13.8	86.44	0.34	1.467	83.16	0.00346	0.1982
-30	20.0	15.7	85.88	0.39	2.941	83.89	0.00690	0.1976
-25	22.6	17.9	85.32	0.44	4.421	84.63	0.01031	0.1970
-20	25.4	20.4	84.75	0.49	5.908	85.35	0.01370	0.1964
-15	28.5	23.0	84.17	0.56	7.402	86.08	0.01707	0.1959
-10	31.8	26.0	83.59	0.62	8.904	86.80	0.02041	0.1955
-5	35.4	29.2	83.00	0.70	10.41	87.51	0.02373	0.1951
0	39.4	32.7	82.41	0.78	11.93	88.22	0.02703	0.1947
5	43.7	36.6	81.81	0.86	13.46	88.92	0.03031	0.1943
10	48.3	40.8	81.20	0.96	14.99	89.62	0.03358	0.1940
15	53.3	45.3	80.58	1.06	16.54	90.31	0.03682	0.1937
20	58.6	50.2	79.95	1.17	18.09	90.99	0.04006	0.1934
25	64.4	55.5	79.32	1.29	19.66	91.66	0.04327	0.1931
30	70.6	61.3	78.67	1.42	21.23	92.33	0.04648	0.1929
35	77.2	67.4	78.01	1.57	22.82	92.99	0.04967	0.1927
40	84.3	74.1	77.35	1.72	24.42	93.63	0.05285	0.1925
45	91.9	81.2	76.67	1.88	26.03	94.26	0.05601	0.1923
50	100	88.8	75.97	2.06	27.65	94.89	0.05917	0.1921
55	109	96.9	75.27	2.25	29.28	95.50	0.06233	0.1919
60	118	106	74.55	2.45	30.93	96.09	0.06547	0.1918
65	127	115	73.81	2.68	32.60	96.67	0.06861	0.1916
70	138	125	73.05	2.91	34.28	97.23	0.07175	0.1914
75	149	135	72.28	3.17	35.97	97.78	0.07489	0.1912
80	160	146	71.49	3.45	37.69	98.30	0.07802	0.1911
85	172	158	70.67	3.74	39.42	98.81	0.08116	0.1909
90	185	170	69.83	4.06	41.17	99.29	0.08430	0.1907
95	199	184	68.96	4.41	42.95	99.74	0.08745	0.1904
100	213	198	68.07	4.78	44.74	100.2	0.09060	0.1902
105	228	212	67.14	5.19	46.57	100.6	0.09377	0.1899
110	244	228	66.18	5.63	48.42	100.9	0.09696	0.1896
115	260	244	65.17	6.11	50.30	101.2	0.1002	0.1893
120	278	262	64.13	6.63	52.21	101.5	0.1034	0.1889
125	296	280	63.03	7.21	54.16	101.8	0.1067	0.1885
130	315	299	61.87	7.83	56.15	101.9	0.1100	0.1879
135	335	319	60.64	8.53	58.20	102.0	0.1133	0.1874
140	357	340	59.32	9.31	60.29	102.1	0.1167	0.1867



Thermodynamic Properties of R-422D

TEMP. (°F)	Pressure Liquid (psia)	Pressure Vapor (psia)	Density Liquid (lb/ft ³)	Density Vapor (lb/ft ³)	Enthalpy Liquid (Btu/lb)	Enthalpy Vapor (Btu/lb)	Entropy Liquid (Btu/R-lb)	Entropy Vapor (Btu/R-lb)
-60	10.0	7.5	89.08	0.20	-5.756	76.71	-0.01402	0.1951
-55	11.5	8.8	88.53	0.23	-4.326	77.45	-0.01047	0.1943
-50	13.1	10.2	87.98	0.26	-2.890	78.19	-0.00695	0.1935
-45	15.0	11.8	87.42	0.30	-1.448	78.92	-0.00346	0.1928
-40	17.1	13.5	86.86	0.34	0.000	79.65	0.00000	0.1921
-35	19.3	15.5	86.30	0.39	1.455	80.39	0.00343	0.1915
-30	21.8	17.7	85.73	0.44	2.916	81.11	0.00684	0.1909
-25	24.6	20.1	85.15	0.50	4.384	81.84	0.01023	0.1904
-20	27.6	22.8	84.57	0.56	5.860	82.56	0.01359	0.1899
-15	30.9	25.7	83.98	0.63	7.343	83.27	0.01693	0.1894
-10	34.5	29.0	83.39	0.71	8.835	83.98	0.02024	0.1890
-5	38.4	32.5	82.79	0.79	10.34	84.69	0.02354	0.1886
0	42.6	36.3	82.18	0.88	11.84	85.39	0.02682	0.1883
5	47.2	40.5	81.56	0.98	13.36	86.08	0.03008	0.1880
10	52.2	45.1	80.93	1.08	14.89	86.77	0.03332	0.1877
15	57.5	50.0	80.30	1.20	16.42	87.45	0.03655	0.1874
20	63.2	55.4	79.66	1.32	17.97	88.12	0.03977	0.1872
25	69.4	61.1	79.00	1.46	19.53	88.78	0.04297	0.1870
30	76.0	67.3	78.34	1.60	21.10	89.43	0.04615	0.1868
35	83.1	74.0	77.66	1.76	22.68	90.08	0.04933	0.1866
40	90.6	81.1	76.97	1.93	24.27	90.71	0.05250	0.1864
45	98.7	88.7	76.27	2.11	25.87	91.33	0.05565	0.1863
50	107	96.9	75.55	2.30	27.49	91.93	0.05880	0.1861
55	116	106	74.82	2.52	29.12	92.53	0.06194	0.1860
60	126	115	74.07	2.74	30.77	93.10	0.06508	0.1858
65	136	125	73.30	2.99	32.43	93.66	0.06822	0.1857
70	147	135	72.52	3.25	34.11	94.21	0.07135	0.1855
75	159	147	71.71	3.54	35.81	94.73	0.07448	0.1853
80	171	158	70.88	3.84	37.53	95.23	0.07762	0.1852
85	184	171	70.03	4.18	39.26	95.70	0.08076	0.1850
90	197	184	69.15	4.53	41.02	96.16	0.08391	0.1848
95	212	198	68.23	4.92	42.80	96.58	0.08706	0.1845
100	227	213	67.29	5.34	44.61	96.97	0.09023	0.1843
105	243	229	66.31	5.80	46.44	97.32	0.09342	0.1840
110	259	245	65.28	6.30	48.31	97.64	0.09662	0.1836
115	277	263	64.21	6.84	50.21	97.91	0.09986	0.1832
120	295	281	63.08	7.44	52.15	98.14	0.1031	0.1828
125	315	300	61.89	8.09	54.13	98.30	0.1064	0.1823
130	335	321	60.63	8.82	56.16	98.40	0.1098	0.1817
135	356	342	59.28	9.63	58.25	98.42	0.1132	0.1810
140	378	364	57.82	10.55	60.41	98.35	0.1167	0.1802



R-500 and R-502

R-500

Composition: (R-12 / 152a) • (73.8 / 26.2 wt%)

Application:

Air conditioning, dehumidifiers and centrifugal chillers

Lubricant:

Mineral oil and alkylbenzene

Retrofitting:

- Consult the comments on Pages 9 and 10
- See Section II, pages 92-98 for detailed discussion

R-502

Composition: (R-22 / 115) • (48.8 / 51.2wt%)

Application: Low temperature commercial and industrial refrigeration and ice machines

Lubricant:

Mineral oil and alkylbenzene

Retrofitting:

- Consult the comments on Pages 9 and 10
- See Section II, pages 92-98 for detailed discussion

[PRESSURE-TEMP CHART]

R-500 psig	TEMP. (°F)	R-502 psig
7.6"	-40	4.1
4.6"	-35	6.5
1.2"	-30	9.2
1.2	-25	12.1
3.2	-20	15.3
5.4	-15	18.8
7.8	-10	22.6
10.4	-5	26.7
13.3	0	31.1
16.4	5	35.9
19.7	10	41.0
23.4	15	46.5
27.3	20	52.4
31.5	25	58.8
36.0	30	65.6
40.9	35	72.8
46.1	40	80.5
51.6	45	88.7
57.6	50	97.4
63.9	55	107
70.6	60	116
77.8	65	127
85.4	70	138
93.5	75	149
102	80	161
111	85	174
121	90	187
131	95	201
141	100	216
152	105	232
164	110	248
177	115	265
189	120	283
203	125	301
217	130	321
232	135	341
248	140	363

[PHYSICAL PROPERTIES OF REFRIGERANTS]

	National R-500	National R-502
Environmental Classification	CFC	CFC
Molecular Weight	99.3	111.6
Boiling Point (1atm, °F)	-28.5	-49.5
Critical Pressure (psia)	605.2	582.8
Critical Temperature (°F)	215.8	177.3
Critical Density (lb./ft ³)	30.7	35.5
Liquid Density (70°F, lb./ft ³)	73	77
Vapor Density (bp, lb./ft ³)	0.329	0.388
Heat of Vaporization (bp, BTU/lb.)	86.4	74.2
Specific Heat Liquid (70 °F, BTU/lb. °F)	0.2782	0.2958
Specific Heat Vapor (1atm, 70 °F, BTU/lb. °F)	0.1725	0.1641
Ozone Depletion Potential (CFC 11 = 1.0)	0.66	0.23
Global Warming Potential (CO ₂ = 1.0)	8077	4657
ASHRAE Standard 34 Safety Rating	A1	A1

[AVAILABLE IN SIZES]

REFRIGERANT	Type	Size
R-500	Cylinder	30 lb.
		125 lb.
R-502	Cylinder	30 lb.
		125 lb.



Thermodynamic Properties of R-500

TEMP. (°F)	Pressure Liquid (psia)	Pressure Vapor (psia)	Density Liquid (lb/ft ³)	Density Vapor (lb/ft ³)	Enthalpy Liquid (Btu/lb)	Enthalpy Vapor (Btu/lb)	Entropy Liquid (Btu/R-lb)	Entropy Vapor (Btu/R-lb)
-60	6.3	6.3	85.26	0.1498	-5.016	85.98	-0.01222	0.2155
-55	7.3	7.3	84.81	0.1713	-3.770	86.63	-0.00913	0.2143
-50	8.4	8.4	84.35	0.1951	-2.519	87.27	-0.00606	0.2131
-45	9.6	9.6	83.89	0.2215	-1.262	87.92	-0.00302	0.2120
-40	11.0	11.0	83.43	0.2506	0.000	88.56	0.00000	0.2110
-35	12.5	12.5	82.97	0.2826	1.268	89.20	0.00299	0.2100
-30	14.2	14.2	82.50	0.3177	2.541	89.83	0.00597	0.2091
-25	16.0	16.0	82.03	0.3561	3.820	90.47	0.00892	0.2083
-20	18.0	18.0	81.55	0.3980	5.106	91.10	0.01185	0.2074
-15	20.2	20.2	81.07	0.4436	6.397	91.73	0.01476	0.2066
-10	22.6	22.6	80.59	0.4932	7.695	92.35	0.01765	0.2059
-5	25.3	25.3	80.10	0.5470	9.000	92.97	0.02052	0.2052
0	28.1	28.1	79.61	0.6053	10.31	93.58	0.02337	0.2045
5	31.3	31.2	79.11	0.6682	11.63	94.19	0.02621	0.2039
10	34.6	34.6	78.61	0.7362	12.96	94.80	0.02903	0.2033
15	38.3	38.2	78.10	0.8095	14.29	95.40	0.03184	0.2027
20	42.2	42.1	77.59	0.8883	15.63	95.99	0.03463	0.2022
25	46.4	46.4	77.07	0.9730	16.98	96.58	0.03741	0.2016
30	50.9	50.9	76.55	1.064	18.34	97.16	0.04017	0.2011
35	55.8	55.7	76.01	1.161	19.70	97.73	0.04292	0.2007
40	61.0	60.9	75.48	1.266	21.08	98.29	0.04566	0.2002
45	66.6	66.5	74.93	1.378	22.46	98.85	0.04838	0.1998
50	72.5	72.4	74.38	1.497	23.85	99.40	0.05110	0.1993
55	78.9	78.7	73.82	1.625	25.25	99.94	0.05381	0.1989
60	85.6	85.4	73.25	1.761	26.66	100.5	0.05650	0.1985
65	92.8	92.5	72.67	1.907	28.09	101.0	0.05919	0.1982
70	100.4	100.1	72.08	2.062	29.52	101.5	0.06187	0.1978
75	108.4	108.1	71.48	2.228	30.96	102.0	0.06455	0.1974
80	116.9	116.6	70.87	2.405	32.42	102.5	0.06722	0.1970
85	125.9	125.5	70.25	2.593	33.89	102.9	0.06988	0.1967
90	135.4	135.0	69.62	2.794	35.37	103.4	0.07254	0.1963
95	145.5	145.0	68.98	3.008	36.86	103.8	0.07520	0.1960
100	156.1	155.5	68.32	3.236	38.37	104.3	0.07785	0.1956
105	167.2	166.6	67.64	3.479	39.89	104.7	0.08051	0.1952
110	178.9	178.2	66.95	3.739	41.43	105.0	0.08316	0.1949
115	191.2	190.4	66.25	4.016	42.99	105.4	0.08582	0.1945
120	204.1	203.3	65.52	4.313	44.56	105.8	0.08849	0.1941
125	217.7	216.8	64.77	4.630	46.15	106.1	0.09115	0.1937
130	231.9	230.9	64.00	4.970	47.77	106.4	0.09383	0.1933
135	246.8	245.7	63.21	5.335	49.40	106.6	0.09652	0.1928
140	262.4	261.2	62.39	5.726	51.06	106.9	0.09922	0.1923
145	278.7	277.4	61.54	6.148	52.74	107.1	0.1019	0.1918
150	295.7	294.4	60.66	6.604	54.45	107.2	0.1047	0.1913
155	313.6	312.1	59.73	7.097	56.20	107.3	0.1074	0.1907



Thermodynamic Properties of R-502

TEMP. (°F)	Pressure Liquid (psia)	Pressure Vapor (psia)	Density Liquid (lb/ft ³)	Density Vapor (lb/ft ³)	Enthalpy Liquid (Btu/lb)	Enthalpy Vapor (Btu/lb)	Entropy Liquid (Btu/R-lb)	Entropy Vapor (Btu/R-lb)
-60	11.1	10.9	93.91	0.2941	-4.736	70.99	-0.01153	0.1781
-55	12.7	12.5	93.35	0.3342	-3.561	71.59	-0.00861	0.1772
-50	14.5	14.3	92.78	0.3786	-2.380	72.18	-0.00572	0.1764
-45	16.5	16.3	92.20	0.4273	-1.193	72.77	-0.00285	0.1756
-40	18.7	18.5	91.62	0.4808	0.000	73.36	0.00000	0.1749
-35	21.1	20.9	91.04	0.5394	1.200	73.95	0.00283	0.1742
-30	23.7	23.5	90.45	0.6034	2.406	74.53	0.00564	0.1736
-25	26.6	26.4	89.85	0.6731	3.619	75.11	0.00843	0.1730
-20	29.8	29.6	89.25	0.7490	4.839	75.68	0.01121	0.1724
-15	33.2	33.0	88.64	0.8313	6.066	76.25	0.01397	0.1719
-10	37.0	36.8	88.03	0.9205	7.301	76.81	0.01671	0.1713
-5	41.0	40.8	87.40	1.017	8.544	77.37	0.01944	0.1709
0	45.4	45.2	86.78	1.121	9.795	77.92	0.02216	0.1704
5	50.1	50.0	86.14	1.234	11.05	78.47	0.02486	0.1700
10	55.2	55.1	85.49	1.355	12.32	79.00	0.02755	0.1696
15	60.7	60.6	84.84	1.486	13.60	79.53	0.03023	0.1692
20	66.6	66.5	84.17	1.626	14.89	80.06	0.03290	0.1688
25	72.9	72.8	83.50	1.777	16.18	80.57	0.03556	0.1684
30	79.6	79.5	82.82	1.939	17.49	81.07	0.03821	0.1681
35	86.8	86.7	82.12	2.113	18.80	81.57	0.04085	0.1677
40	94.5	94.4	81.42	2.299	20.13	82.05	0.04348	0.1674
45	102.7	102.6	80.70	2.499	21.47	82.52	0.04611	0.1671
50	111.4	111.3	79.97	2.712	22.82	82.98	0.04874	0.1668
55	120.6	120.5	79.22	2.942	24.18	83.43	0.05135	0.1665
60	130.4	130.3	78.46	3.187	25.56	83.86	0.05397	0.1662
65	140.7	140.7	77.68	3.450	26.95	84.28	0.05658	0.1659
70	151.7	151.6	76.88	3.731	28.35	84.68	0.05920	0.1656
75	163.3	163.2	76.07	4.033	29.77	85.07	0.06181	0.1652
80	175.5	175.4	75.23	4.357	31.20	85.43	0.06442	0.1649
85	188.4	188.3	74.37	4.705	32.66	85.78	0.06704	0.1646
90	201.9	201.9	73.49	5.079	34.13	86.10	0.06967	0.1642
95	216.2	216.2	72.58	5.481	35.62	86.40	0.07230	0.1639
100	231.3	231.2	71.64	5.914	37.13	86.67	0.07495	0.1635
105	247.1	247.0	70.66	6.382	38.67	86.91	0.07761	0.1630
110	263.6	263.6	69.65	6.889	40.23	87.11	0.08029	0.1626
115	281.0	281.0	68.59	7.438	41.82	87.28	0.08298	0.1621
120	299.3	299.3	67.48	8.037	43.44	87.41	0.08571	0.1616
125	318.4	318.4	66.32	8.692	45.10	87.49	0.08847	0.1610
130	338.5	338.5	65.08	9.412	46.80	87.51	0.09127	0.1603
135	359.5	359.5	63.77	10.21	48.55	87.47	0.09412	0.1596
140	381.4	381.4	62.36	11.10	50.36	87.35	0.09704	0.1587



R-503

R-503

Composition: (R-23 / 13) • (40.1 / 59.9 wt%)

Application:

Very low temperature refrigeration (low stage of a cascade system)

Performance:

- R-503 runs with better capacity and lower discharge pressure than R-13
- Operates in the low temperature stage of a cascade system because of its low boiling point

Lubricant:

- Compatible with mineral oil
- Hydrocarbon additives are often added to a system to improve oil circulation at very low temperatures

Retrofitting:

- Consult the comments on Page 10
- See Ultra Low Temperature Refrigeration Section (pages 66-67)

[PRESSURE-TEMP CHART]

TEMP. (°F)	R-503 psig
-125	0.5
-120	3.1
-115	6.0
-110	9.3
-105	12.9
-100	16.9
-95	21.4
-90	26.3
-85	31.8
-80	37.7
-75	44.2
-70	51.3
-65	59.0
-60	67.3
-55	76.4
-50	86.1
-45	96.6
-40	108
-35	120
-30	133
-25	147
-20	161
-15	177
-10	194
-5	212
0	230
5	250
10	272
15	294
20	318

[PHYSICAL PROPERTIES OF REFRIGERANTS]

	National R-503
Environmental Classification	CFC
Molecular Weight	87.25
Boiling Point (1atm, °F)	-125.5
Critical Pressure (psia)	618.6
Critical Temperature (°F)	65.2
Critical Density (lb./ft ³)	34.4
Liquid Density (20°F, lb./ft ³)	68.4
Vapor Density (bp, lb./ft ³)	0.373
Heat of Vaporization (bp, BTU/lb.)	77.1
Specific Heat Liquid (20°F, BTU/lb. °F)	0.3671
Specific Heat Vapor (1atm, 20°F, BTU/lb. °F)	0.1537
Ozone Depletion Potential (CFC 11 = 1.0)	0.06
Global Warming Potential (CO2 = 1.0)	14560
ASHRAE Standard 34 Safety Rating	A1

[AVAILABLE IN SIZES]

REFRIGERANT	Type	Size
R-503	Cylinder	5 lb.
		9 lb.
		20 lb.
		80 lb.



Thermodynamic Properties of R-503

TEMP. (°F)	Pressure Liquid (psia)	Pressure Vapor (psia)	Density Liquid (lb/ft ³)	Density Vapor (lb/ft ³)	Enthalpy Liquid (Btu/lb)	Enthalpy Vapor (Btu/lb)	Entropy Liquid (Btu/R-lb)	Entropy Vapor (Btu/R-lb)
-140	9.1	9.1	94.67	0.2374	-25.81	53.32	-0.06936	0.1782
-135	10.8	10.8	94.04	0.2788	-24.60	53.82	-0.06562	0.1759
-130	12.7	12.7	93.40	0.3257	-23.39	54.30	-0.06192	0.1737
-125	14.9	14.9	92.75	0.3785	-22.16	54.79	-0.05826	0.1717
-120	17.4	17.4	92.09	0.4377	-20.94	55.26	-0.05464	0.1697
-115	20.3	20.2	91.43	0.5039	-19.70	55.73	-0.05105	0.1678
-110	23.5	23.4	90.75	0.5776	-18.46	56.19	-0.04748	0.1660
-105	27.0	26.9	90.06	0.6595	-17.21	56.64	-0.04395	0.1643
-100	31.0	30.9	89.36	0.7500	-15.95	57.08	-0.04045	0.1627
-95	35.4	35.2	88.65	0.8500	-14.68	57.51	-0.03698	0.1611
-90	40.2	40.0	87.93	0.9601	-13.40	57.93	-0.03352	0.1595
-85	45.6	45.3	87.19	1.081	-12.12	58.34	-0.03010	0.1580
-80	51.4	51.1	86.44	1.214	-10.82	58.74	-0.02669	0.1566
-75	57.9	57.5	85.67	1.359	-9.512	59.12	-0.02330	0.1552
-70	64.9	64.4	84.89	1.517	-8.192	59.49	-0.01993	0.1539
-65	72.5	72.0	84.09	1.690	-6.861	59.85	-0.01658	0.1525
-60	80.8	80.1	83.28	1.878	-5.517	60.19	-0.01324	0.1513
-55	89.7	89.0	82.45	2.083	-4.159	60.51	-0.00992	0.1500
-50	99.4	98.6	81.60	2.306	-2.788	60.82	-0.00660	0.1488
-45	109.9	108.9	80.72	2.549	-1.402	61.11	-0.00330	0.1476
-40	121.1	120.0	79.83	2.812	0.000	61.37	0.00000	0.1464
-35	133.2	131.9	78.91	3.097	1.419	61.62	0.00329	0.1452
-30	146.1	144.7	77.96	3.408	2.855	61.84	0.00659	0.1440
-25	160.0	158.3	76.99	3.745	4.312	62.04	0.00988	0.1428
-20	174.8	172.9	75.99	4.112	5.789	62.21	0.01318	0.1416
-15	190.5	188.5	74.95	4.511	7.289	62.35	0.01648	0.1404
-10	207.3	205.1	73.87	4.946	8.813	62.45	0.01980	0.1392
5	225.2	222.7	72.76	5.421	10.37	62.52	0.02313	0.1379
0	244.1	241.5	71.59	5.941	11.95	62.54	0.02648	0.1367
5	264.2	261.4	70.37	6.512	13.56	62.52	0.02987	0.1353
10	285.6	282.5	69.09	7.142	15.22	62.44	0.03329	0.1339
15	308.1	304.8	67.74	7.839	16.92	62.30	0.03676	0.1325
20	332.0	328.5	66.31	8.616	18.67	62.09	0.04029	0.1309



R-507

R-507

Composition: (R-125 / 143a) • (50 / 50 wt%)

Application:

Medium and low temperature commercial and industrial refrigeration and ice machines

Performance:

- Similar to R-404A in operation
- Pressure and capacity are slightly higher than R-404A

Lubricant:

Polyolester lubricant

Retrofitting:

- Consult the comments on Pages 9 and 10
- See Section II, pages 92-98 for detailed discussion

[PRESSURE-TEMP CHART]

TEMP. (°F)	R-507 psig
-40	5.5
-35	8.2
-30	11.1
-25	14.3
-20	17.8
-15	21.7
-10	25.8
-5	30.3
-0	35.2
5	40.5
10	46.1
15	52.2
20	58.8
25	65.8
30	73.3
35	81.3
40	89.8
45	98.9
50	109
55	119
60	130
65	141
70	154
75	167
80	180
85	195
90	210
95	226
100	244
105	252
110	281
115	301
120	322
125	344
130	368
135	393
140	419
145	446
150	475

[PHYSICAL PROPERTIES OF REFRIGERANTS]

	National R-507
Environmental Classification	HFC
Molecular Weight	98.9
Boiling Point (1atm, °F)	-52.8
Critical Pressure (psia)	539
Critical Temperature (°F)	159
Critical Density (lb./ft ³)	30.7
Liquid Density (70°F, lb./ft ³)	66.65
Vapor Density (bp.lb./ft ³)	0.349
Heat of Vaporization (bp, BTU/lb.)	84.35
Specific Heat Liquid (70°F, BTU/lb. °F)	0.3593
Specific Heat Vapor (1atm, 70°F, BTU/lb. °F)	0.2064
Ozone Depletion Potential (CFC 11 = 1.0)	0
Global Warming Potential (CO2 = 1.0)	3985
ASHRAE Standard 34 Safety Rating	A1

[AVAILABLE IN SIZES]

REFRIGERANT	Type	Size
R-507	Cylinder	25 lb.
		100 lb.
		800 lb.
		1,400 lb.



Thermodynamic Properties of R-507

TEMP. (°F)	Pressure Liquid (psia)	Pressure Vapor (psia)	Density Liquid (lb/ft ³)	Density Vapor (lb/ft ³)	Enthalpy Liquid (Btu/lb)	Enthalpy Vapor (Btu/lb)	Entropy Liquid (Btu/R-lb)	Entropy Vapor (Btu/R-lb)
-60	12.1	12.1	83.10	0.2899	-5.871	79.54	-0.01429	0.1994
-55	13.9	13.9	82.57	0.3298	-4.416	80.26	-0.01068	0.1986
-50	15.8	15.8	82.03	0.3738	-2.952	80.98	-0.00709	0.1978
-45	18.0	18.0	81.49	0.4223	-1.480	81.69	-0.00354	0.1970
-40	20.4	20.4	80.94	0.4756	0.000	82.40	0.00000	0.1964
-35	23.1	23.1	80.39	0.5340	1.489	83.11	0.00351	0.1957
-30	26.0	26.0	79.83	0.5980	2.987	83.81	0.00700	0.1951
-25	29.2	29.2	79.27	0.6678	4.494	84.51	0.01047	0.1946
-20	32.7	32.7	78.70	0.7439	6.010	85.20	0.01392	0.1940
-15	36.5	36.5	78.12	0.8267	7.537	85.88	0.01735	0.1935
-10	40.7	40.7	77.53	0.9166	9.073	86.56	0.02077	0.1931
-5	45.2	45.2	76.94	1.014	10.62	87.23	0.02417	0.1927
0	50.1	50.0	76.34	1.120	12.18	87.89	0.02755	0.1923
5	55.3	55.3	75.73	1.234	13.75	88.55	0.03091	0.1919
10	61.0	60.9	75.11	1.357	15.33	89.19	0.03427	0.1915
15	67.1	67.0	74.48	1.491	16.92	89.83	0.03761	0.1912
20	73.6	73.6	73.84	1.634	18.52	90.45	0.04094	0.1909
25	80.6	80.6	73.18	1.789	20.14	91.07	0.04426	0.1906
30	88.1	88.1	72.52	1.956	21.77	91.67	0.04757	0.1903
35	96.1	96.1	71.84	2.136	23.42	92.26	0.05087	0.1900
40	104.7	104.6	71.15	2.329	25.08	92.84	0.05417	0.1898
45	113.8	113.7	70.45	2.537	26.76	93.40	0.05746	0.1895
50	123.5	123.4	69.73	2.761	28.45	93.94	0.06075	0.1892
55	133.8	133.7	68.99	3.002	30.17	94.47	0.06404	0.1890
60	144.7	144.6	68.23	3.262	31.90	94.97	0.06733	0.1887
65	156.3	156.1	67.45	3.541	33.65	95.46	0.07062	0.1884
70	168.5	168.3	66.65	3.843	35.42	95.92	0.07392	0.1882
75	181.5	181.3	65.82	4.169	37.21	96.36	0.07722	0.1879
80	195.1	194.9	64.97	4.521	39.03	96.77	0.08053	0.1875
85	209.6	209.4	64.08	4.902	40.87	97.15	0.08386	0.1872
90	224.8	224.6	63.17	5.315	42.75	97.50	0.08720	0.1868
95	240.8	240.6	62.21	5.764	44.65	97.80	0.09056	0.1864
100	257.7	257.5	61.21	6.255	46.59	98.07	0.09395	0.1859
105	275.5	275.2	60.17	6.792	48.57	98.28	0.09737	0.1854
110	294.2	293.9	59.07	7.382	50.59	98.43	0.1008	0.1848
115	313.8	313.5	57.91	8.035	52.66	98.52	0.1043	0.1842
120	334.4	334.1	56.67	8.762	54.79	98.53	0.1079	0.1834
125	356.1	355.8	55.34	9.580	56.98	98.44	0.1116	0.1825
130	378.8	378.6	53.89	10.51	59.26	98.24	0.1153	0.1814
135	402.7	402.5	52.29	11.59	61.64	97.87	0.1192	0.1801
140	427.9	427.6	50.50	12.86	64.17	97.30	0.1233	0.1785



R-508B

R-508B

Replaces: (R-23 / 116) • (46 / 54 wt%)

Replaces: R-503 & R-13

Application:

Very low temperature refrigeration (low stage of a cascade system)

Performance:

- PT properties are very similar to R-503 and can be used to replace R-13 or R-503 in an existing system
- Higher capacity and lower discharge temperature compared to R-23

Lubricant Recommendation:

- Compatible with polyolester
- Hydrocarbon additives are often added to a system to improve oil circulation at very low temperatures

Retrofitting:

- Consult the comments on Page 10
- See Ultra Low Temperature Refrigeration Section (pages 66-67)

[PRESSURE-TEMP CHART]

TEMP. (°F)	R-508B psig
-125	0.5
-120	3.1
-115	6.0
-110	9.3
-105	12.9
-100	16.9
-95	21.4
-90	26.4
-85	31.8
-80	37.8
-75	44.4
-70	51.5
-65	59.3
-60	67.8
-55	76.9
-50	86.8
-45	97.5
-40	109
-35	121
-30	135
-25	149
-20	164
-15	180
-10	197
-5	216
0	235
5	256
10	278
15	301
20	326

[PHYSICAL PROPERTIES OF REFRIGERANTS]

	National R-508B
Environmental Classification	HFC
Molecular Weight	95.4
Boiling Point (1atm, °F)	-125.3
Critical Pressure (psia)	556.1
Critical Temperature (°F)	53.7
Critical Density (lb./ft ³)	35.6
Liquid Density (20°F, lb./ft ³)	65.4
Vapor Density (bp, lb./ft ³)	0.426
Heat of Vaporization (bp, BTU/lb.)	71.4
Specific Heat Liquid (20°F, BTU/lb. °F)	0.4221
Specific Heat Vapor (1atm, 20°F, BTU/lb. °F)	0.1701
Ozone Depletion Potential (CFC 11 = 1.0)	0
Global Warming Potential (CO2 = 1.0)	13400
ASHRAE Standard 34 Safety Rating	A1

[AVAILABLE IN SIZES]

REFRIGERANT	Type	Size
	R-508B	Cylinder
	10 lb.	
	20 lb.	
	70 lb.	



Thermodynamic Properties of R-508B

TEMP. (°F)	Pressure Liquid (psia)	Pressure Vapor (psia)	Density Liquid (lb/ft ³)	Density Vapor (lb/ft ³)	Enthalpy Liquid (Btu/lb)	Enthalpy Vapor (Btu/lb)	Entropy Liquid (Btu/R-lb)	Entropy Vapor (Btu/R-lb)
-160	4.1	3.9	100.7	0.1181	-32.27	44.15	-0.08953	0.1664
-155	5.1	4.8	99.96	0.1438	-30.98	44.72	-0.08527	0.1640
-150	6.2	5.9	99.24	0.1737	-29.70	45.29	-0.08109	0.1618
-145	7.5	7.2	98.52	0.2083	-28.42	45.85	-0.07699	0.1596
-140	8.9	8.6	97.80	0.2482	-27.14	46.40	-0.07297	0.1576
-135	10.6	10.3	97.08	0.2937	-25.86	46.95	-0.06900	0.1557
-130	12.6	12.3	96.37	0.3455	-24.57	47.49	-0.06509	0.1539
-125	14.8	14.5	95.65	0.4041	-23.29	48.03	-0.06124	0.1522
-120	17.4	17.1	94.92	0.4701	-22.00	48.56	-0.05743	0.1505
-115	20.2	19.9	94.19	0.5441	-20.70	49.08	-0.05366	0.1490
-110	23.4	23.1	93.45	0.6269	-19.40	49.59	-0.04993	0.1476
-105	27.0	26.7	92.70	0.7191	-18.09	50.10	-0.04623	0.1462
-100	31.0	30.8	91.94	0.8214	-16.77	50.59	-0.04256	0.1449
-95	35.5	35.2	91.18	0.9347	-15.45	51.08	-0.03892	0.1436
-90	40.4	40.1	90.39	1.060	-14.11	51.56	-0.03531	0.1424
-85	45.8	45.6	89.60	1.198	-12.76	52.02	-0.03172	0.1412
-80	51.7	51.6	88.79	1.349	-11.40	52.48	-0.02815	0.1401
-75	58.3	58.1	87.96	1.515	-10.03	52.92	-0.02460	0.1391
-70	65.4	65.3	87.12	1.697	-8.648	53.35	-0.02106	0.1381
-65	73.2	73.0	86.25	1.896	-7.249	53.76	-0.01753	0.1371
-60	81.6	81.5	85.36	2.114	-5.834	54.17	-0.01402	0.1361
-55	90.7	90.7	84.45	2.351	-4.403	54.55	-0.01051	0.1352
-50	100.6	100.6	83.51	2.611	-2.955	54.92	-0.00701	0.1343
-45	111.3	111.3	82.55	2.893	-1.487	55.27	-0.00350	0.1334
-40	122.8	122.8	81.55	3.202	0.000	55.60	0.00000	0.1325
-35	135.2	135.1	80.52	3.539	1.509	55.90	0.00351	0.1316
-30	148.4	148.4	79.45	3.906	3.041	56.18	0.00702	0.1307
-25	162.6	162.6	78.34	4.308	4.598	56.44	0.01055	0.1298
-20	177.8	177.8	77.18	4.748	6.182	56.66	0.01409	0.1289
-15	194.0	194.0	75.98	5.231	7.796	56.85	0.01765	0.1280
-10	211.3	211.3	74.72	5.763	9.441	56.99	0.02123	0.1270
-5	229.7	229.6	73.40	6.350	11.12	57.10	0.02484	0.1260
0	249.3	249.2	72.02	7.000	12.84	57.15	0.02849	0.1249
5	270.1	270.0	70.56	7.725	14.59	57.13	0.03218	0.1237
10	292.2	292.1	69.02	8.540	16.40	57.05	0.03592	0.1225
15	315.7	315.6	67.39	9.461	18.26	56.88	0.03972	0.1211
20	340.6	340.5	65.63	10.52	20.18	56.60	0.04361	0.1195



Ultra-Low Temperature Refrigeration

Ultra-low temperature systems are used to achieve low temperature baths or boxes for laboratory use, storage of pharmaceutical or biological samples, low temperature manufacturing of metals, or extreme-temperature-environment testing.

The lowest temperature that can practically be achieved in single-stage refrigeration systems is about -40°F to -50°F. A single-stage system is limited by the compression ratio of the compressor and the ambient temperature in which it must condense the refrigerant. Temperatures from -50°F down to -120°F or lower can only be achieved economically by using cascade refrigeration systems.

A typical cascade system is shown in **Figure 1**. A standard refrigeration system is used on the “high side” (a) to create a cold temperature in the cascade condenser (b). The “low side” system (c) is able to condense at -20°F to -30°F and evaporate as low as -120°F with the available refrigerants before they go into vacuum. Larger systems tend to have some kind of oil separator and oil management system (d) to keep the oil in the compressor. Some systems also employ an expansion tank (e) to keep the refrigerant from generating extreme pressures at room temperature when the system is off.

Figure 1: CASCADE SYSTEM

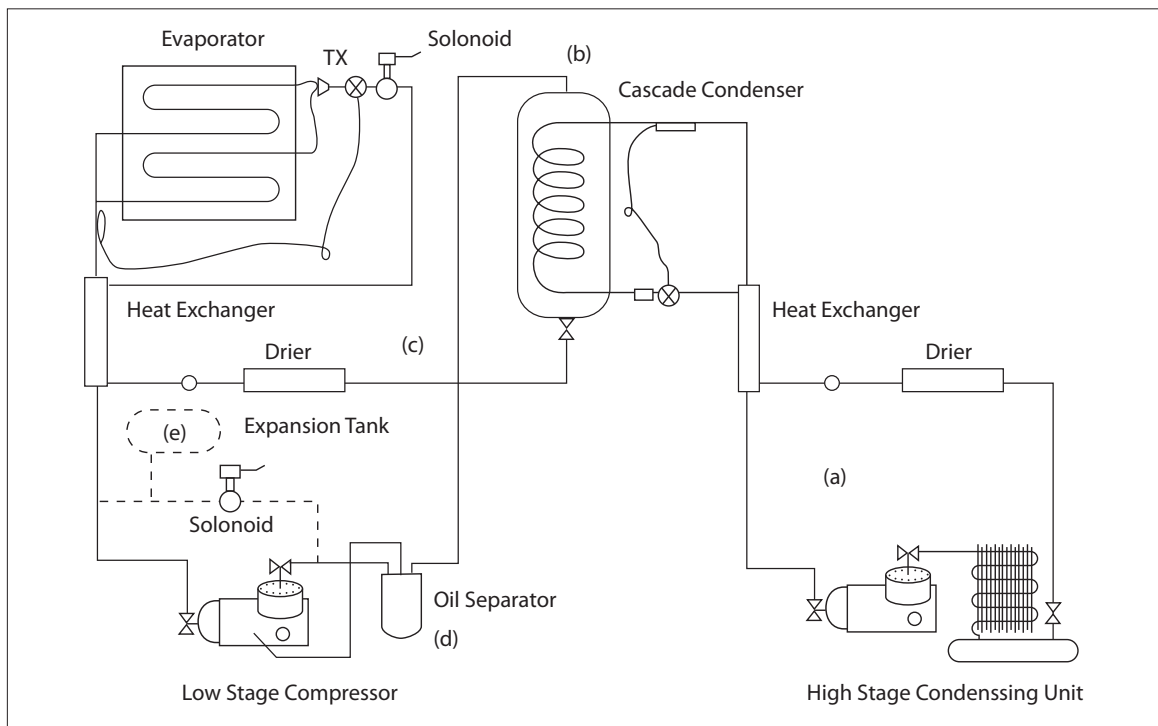

Traditional High Side Refrigerants:	R-12	R-22	R-502
Alternative High Side Refrigerants:	R-134a	R-404A	R-507
Traditional Low Side Refrigerants:	R-13	R-503	
Alternative Low Side Refrigerants:	R-23	R-508B	



Oil Circulation: Standard refrigeration oils will become very thick at low temperatures and will not flow around the system back to the compressor. If the compressor gets too cold, the oil will gel inside the compressor sump and not provide lubrication. Many systems rely on the refrigerant to soak into the oil and move it around the system. This method of oil circulation works well down to about -100°F evaporator temperature. In addition, systems with short run times will allow the oil to return to the compressor when the evaporator warms.

Systems that run for longer times at colder temperatures, or involve complicated piping, will need to use an oil separator after the low stage compressor(s). Hydrocarbon refrigerants are typically added to the system so they can soak into the oil and keep it fluid at very low temperatures. The amount of hydrocarbon used is typically between 5 - 10% (by weight) of the refrigerant charge.

National Refrigerants, Inc. supplies the following hydrocarbons for use in cascade systems:

Part Number	Size	Product	
3R170	3 lb. cylinder	R-170	ETHANE
004R170	4 oz. cylinder	R-170	ETHANE
004R1150	4 oz cylinder	R-1150	ETHYLENE
016R600	16 oz. cylinder	R-600	BUTANE
016R600a	16 oz. cylinder	R-600a	ISOBUTANE
014R290	14 oz. cylinder	R-290	PROPANE
016RPENTANE	16 oz. can	PENTANE LIQUID	

Moisture: Removal of moisture is more important in cascade systems than it is at higher temperature ranges. Refrigerants such as R-22 and R-404A can absorb and carry much more water than the 10 ppm specified in AHRI-700 and the 30 to 50 ppm indication level of a sight glass. In contrast, R-13 is estimated to only hold about 0.1 ppm of water at -80°F. Excess moisture will definitely separate from the refrigerant and clog capillary tubes or cause other problems. Maintenance of driers is very important in the low stage of a cascade system.

Expansion Volume: Refrigerants in the low stage must maintain “normal” operating pressures in the compressor at very low temperatures. These refrigerants will condense around -30°F to -20°F at pressures from 110 psig to 160 psig. When these refrigerants warm up to room temperature, however, the saturation pressure, or in some cases the critical pressure, can exceed 700 psig.

Rather than incurring the expense of building systems to withstand these pressures, an expansion tank or other system volume is provided. The charge expands into the extra volume, allowing all liquid to boil completely to vapor. Simple gas laws dictate how much volume is needed to keep the charge at a gas pressure of usually no more than 250 psig. Consequently, systems are often charged simply by bringing the uncharged system up to a manufacturer-specified static pressure.

For additional information on Retrofitting, see pages 92-98



Refrigerant Color Codes (AHRI Guideline N)

REFRIGERANT	CHEMICAL NAME	COLOR	PMS #
R-11	Trichlorofluoromethane	Orange	021
R-12	Dichlorodifluoromethane	White	N/A
R-13	Chlorotrifluoromethane	Light Blue	2975
R-113	Trichlorotrifluoroethane	Dark Purple	266
R-114	Dichlorotetrafluoroethane	Navy Blue	302
R-22	Chlorodifluoromethane	Light Green	352
R-23	Trifluoromethane	Light Blue Gray	428
R-123	Dichlorotrifluoroethane	Light Blue Gray	428
R-124	Chlorotetrafluoroethane	DOT Green	335
R-134a	Tetrafluoroethane	Light Blue	2975
R-401A	Chlorodifluoromethane, Difluoroethane, Chlorotetrafluoroethane	Pinkish-Red	177
R-401B	Chlorodifluoromethane, Difluoroethane, Chlorotetrafluoroethane	Yellow-Brown	124
R-402A	Chlorodifluoromethane, Pentafluoroethane, Propane	Light Brown	461
R-402B	Chlorodifluoromethane, Pentafluoroethane, Propane	Green-Brown	385
R-403B	Chlorodifluoromethane, Octafluoropropane, Propane	Light Gray	413
R-404A	Pentafluoroethane, Trifluoroethane, Tetrafluoroethane	Orange	021
R-407A	Difluoromethane, Pentafluoroethane, Tetrafluoroethane	Lime Green	368
R-407C	Difluoromethane, Pentafluoroethane, Tetrafluoroethane	Brown	471
R-408A	Chlorodifluoromethane, Trifluoroethane, Pentafluoroethane	Medium Purple	248
R-409A	Chlorodifluoromethane, Chlorotetrafluoroethane, Chlorodifluoroethane	Medium Brown	465
R-410A	Difluoromethane, Pentafluoroethane	Rose	507
R-414B	Chlorodifluoromethane, Chlorotetrafluoroethane, Chlorodifluoroethane, Isobutane	Medium Blue	2995
R-417C	Pentafluoroethane, Tetrafluoroethane, Butane	Light Grey	—
R-422B	Pentafluoroethane, Tetrafluoroethane, Isobutane	Navy Blue	—
R-422C	Pentafluoroethane, Tetrafluoroethane, Isobutane	Yellow	123
R-422D	Pentafluoroethane, Tetrafluoroethane, Isobutane	Green-Yellow	375
R-500	Dichlorodifluoromethane, Difluoroethane	Yellow	109
R-502	Chlorodifluoromethane, Chloropentafluoroethane	Light Purple	251
R-503	Chlorotrifluoromethane, Trifluoromethane	Blue -Green	3268
R-507	Pentafluoroethane, Trifluoroethane	Aqua Blue	326
R-508B	Trifluoromethane, Hexafluoroethane	Navy Blue	302



RETROFITS AND CONVERSIONS

PG: 70-89 INTRODUCTION TO RETROFITTING: BLENDS TUTORIAL

- 71 Fractionation
- 79 Temperature Glide
- 87 Application Property Match

PG: 90-98 RETROFITTING GUIDELINES AND PROCEDURES

- 90 Checklist and Data Sheet
- 92 R-22 Alternative Retrofit Guidelines
- 94 General Retrofit Procedures
- 96 Sizing Thermostatic Expansion Devices (TXV)





Introduction to Retrofitting: Blends Tutorial

Background

The components of a specific piece of air conditioning or refrigeration equipment have been engineered specifically around the properties of the recommended refrigerant. When replacement of that refrigerant becomes necessary for technical, regulatory, or economic reasons, the replacement refrigerant should have as many properties similar to the original refrigerant as possible. This will minimize hardware changes, controls adjustments, or other time consuming operations such as oil changes.

Since the late 1980s, the development of blends has focused on matching the properties of the original refrigerant in order to offer some advantage over other competing blends. Early R-12 blends focused on evaporator performance in refrigeration systems; however, it became clear that more R-12 was sold for use in automotive air conditioning rather than in refrigeration. Since these systems experience higher condenser temperatures, a second wave of blends came into the market that had lower head pressures.

Manufacturers introduced R-502 retrofit blends that simply removed the R-115, a CFC, and mixed HFC components with R-22. While this approach was very effective at reducing R-502 use during the transition from CFCs in the mid 1990's, it now leaves equipment owners with the challenge of replacing the HCFC-based blends again.

As early as 1992, manufacturers and suppliers of R-22 based air conditioning equipment were looking for alternatives. While the focus was mainly on replacing R-22 for newly built equipment, several retrofit blends were also identified in the process.

Today

2010 was the first year when R-22 was not allowed for use in new equipment. In addition, since 2010 the amount of R-22 available for service has been subject to governmental restrictions. As long as R-22 is available for service, it is still the best technical and economical choice. In some market segments, however, there has been environmental or economic pressure to retrofit (for example, in the supermarket industry). As these pressures shift to residential air conditioning or small refrigeration applications, the need for retrofitting will increase. Finally, R-22-containing blends that were previously used to retrofit CFC systems may also require changeover to chlorine-free blends.

Blends Tutorial

The following information is designed to help technicians understand how blends are different from single-component refrigerants. Fractionation and temperature glide are explained in a way that shows the effect on system operation and controls. Actual products and their impact on the market are discussed, and retrofit procedures are provided for a variety of products and equipment.

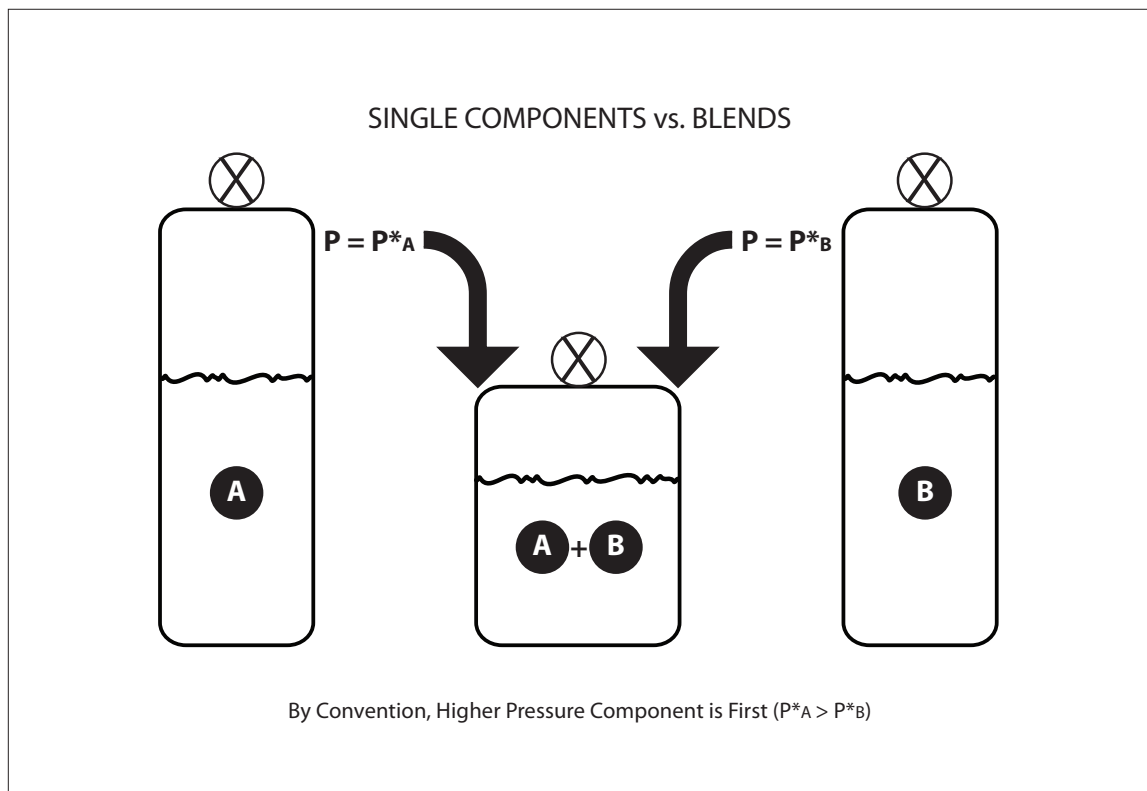

Blends are made up of two or more single component refrigerants. When mixing refrigerants, for example, refrigerant “A” and refrigerant “B”, we generally speak about the higher pressure, higher capacity component first. For purposes of this tutorial, “A” will be the higher pressure product.

When two or more refrigerants are placed into the same container, one of two situations will occur, depending on how strongly the different molecules are attracted to each other:

Azeotrope: a blend that behaves like a single component refrigerant. When a blend forms an azeotrope, it displays unique and unexpected properties.

Zeotrope: a blend that behaves like a mixture of the individual components. Zeotropes have predictable properties based on combinations of the pure components’ properties.

Two properties of concern are Fractionation and Temperature Glide. We can split the zeotropic blends into Low Fractionation Potential, which also exhibit Low Temperature Glide, and High Fractionation Potential, which also exhibit High Temperature Glide. Generally speaking, zeotropic blends with lower temperature glides do not show the same problems with fractionation that are seen with higher glide blends.

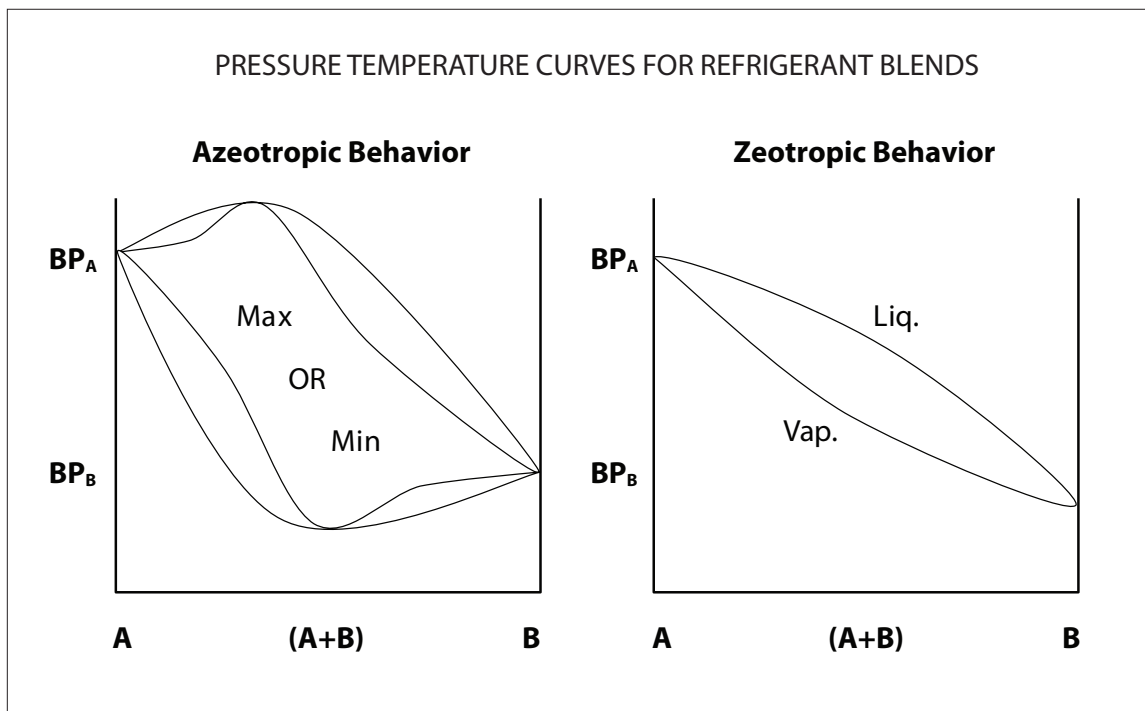

Azeotrope: a special case where the refrigerants combine in a unique way. In an azeotropic composition, the blend behaves like a single refrigerant with its own pressure-temperature (P-T) relationship. The pressure after mixing is either higher than the pressures of the individual components, or is lower than either component. Because the refrigerants are attracted to each other in a special way, the vapor in equilibrium with the liquid is at the same composition during phase change.

Note: The azeotropic composition depends on temperature. The same combination of refrigerants may form an azeotrope at a different ratio, or not at all, at some other temperature.

Zeotrope: the P-T relationship is a natural combination of the components' properties. The pressure for the blend falls between the pressures of its components and can be calculated according to established formulas. Considering the P-T relationship for each refrigerant, the resulting pressure and the vapor composition above the liquid for any given liquid composition can be calculated.

In general, if a lot of A is mixed with B, then the blend will have a pressure close to A. If more B is in the mix, then the blend will have a pressure close to B. If you mix equal amounts, the resulting pressure will fall in between. Blend compositions can be adjusted so the blend properties fall exactly where you want.

The problem, however, is that you usually can't get all the properties to match the original refrigerant under all conditions. You must trade off which properties you want to match and which ones that will be different.



Once a blend is mixed at a given composition, the P-T relationships follow the same general rules for pure components; for example, the pressure goes up when the temperature goes up. For three blends containing different amounts of A and B, the pressure curve is similarly shaped, but the resulting pressure will be higher for the blend which contains more of the A (higher pressure) component.

Refrigerant blends that are intended to match some other product (R-22, for example) will rarely match the pressure at all points in the desired temperature range. More commonly, the pressure of the blend will match in one temperature range, but will be different elsewhere.

In the figure below, the blend with concentration C1 matches the pure refrigerant at cold evaporator temperatures, but the pressure runs higher at condenser conditions. The blend with composition C2 matches closer to room temperature and, for example, might show the same pressure in a cylinder being stored. The operating pressures at evaporator and condenser temperatures, however, will be somewhat different. Finally, the blend at C3 will generate the same pressures at hot condenser conditions, but the evaporator must run at lower pressures to get the same temperature. The choice of where the blend matches the pressure relationship can solve (or cause) certain retrofit-related problems.

The other thing that can be seen from this graph is that if a blend loses some of the higher-pressure component through fractionation, the remaining blend will have lower operating pressures in order to achieve the same temperatures. (*see chart below)

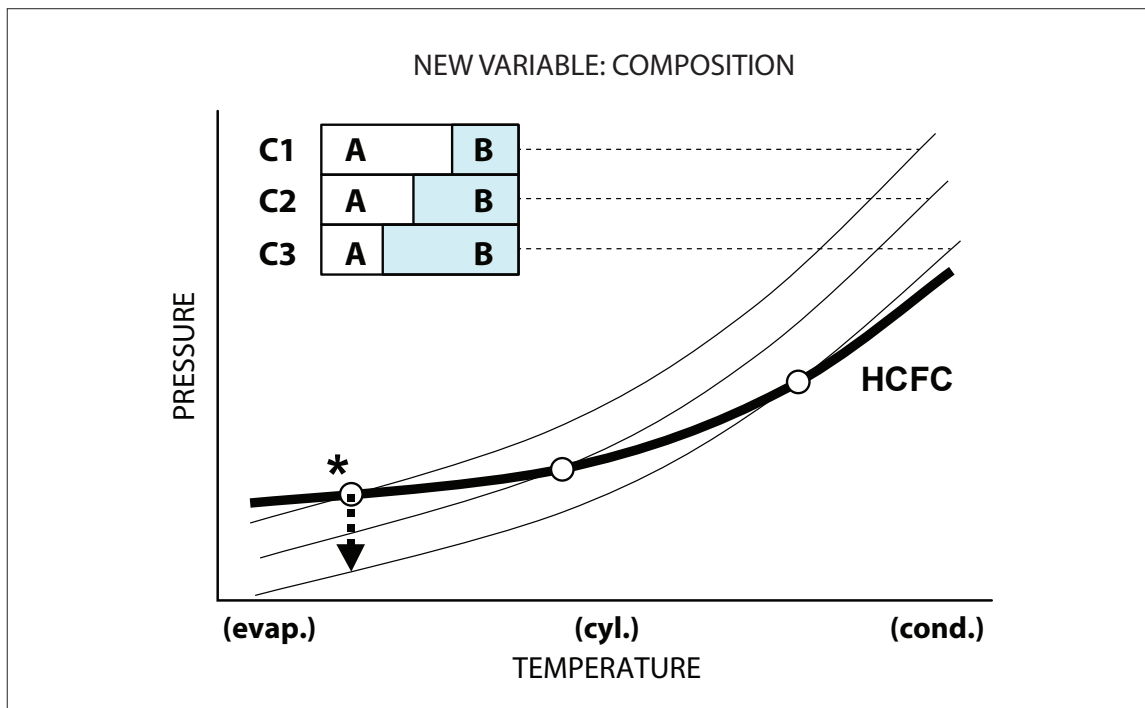

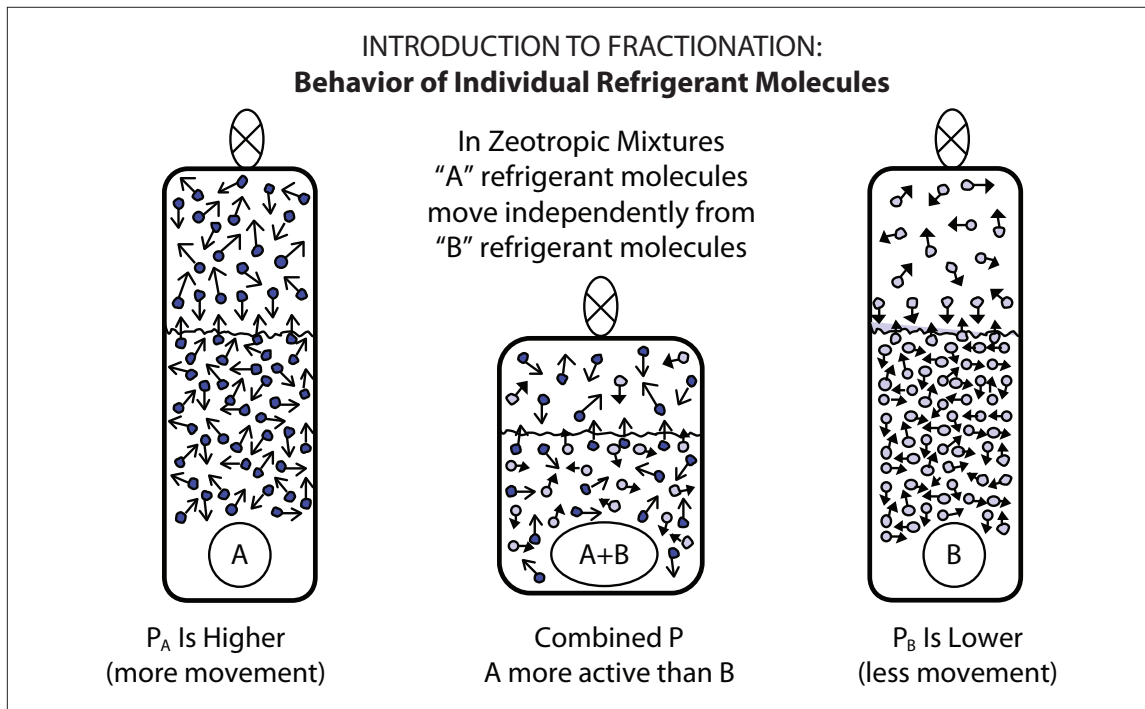

There are two basic behaviors of refrigerant molecules that will help explain why fractionation occurs.

1. Pure refrigerants, A or B, exert pressure on the cylinder (or a system) because the molecules are moving around. At higher temperatures, they move around faster, which creates more pressure. At lower temperatures there is less movement, so the pressure is lower.

Different refrigerants have different energies at the same temperature, and therefore, generate higher or lower pressures.

2. Molecules of refrigerant are constantly moving from liquid to vapor and vapor to liquid at the surface of the liquid. Vapor and liquid at equilibrium transfer the same number of molecules back and forth; boiling liquid transfers more from liquid to vapor; and condensing vapor transfers more from vapor to liquid.

Different refrigerants transfer molecules back and forth to the vapor at different rates.

When you mix A and B together, and they don't form an azeotrope, the individual refrigerant molecules behave as if the other type is not there. The A's bounce harder than the B's, contributing more pressure to the blend, but more importantly — the A's transfer back and forth to the vapor faster than the B's. This means there are more A's in the vapor than there are B's.

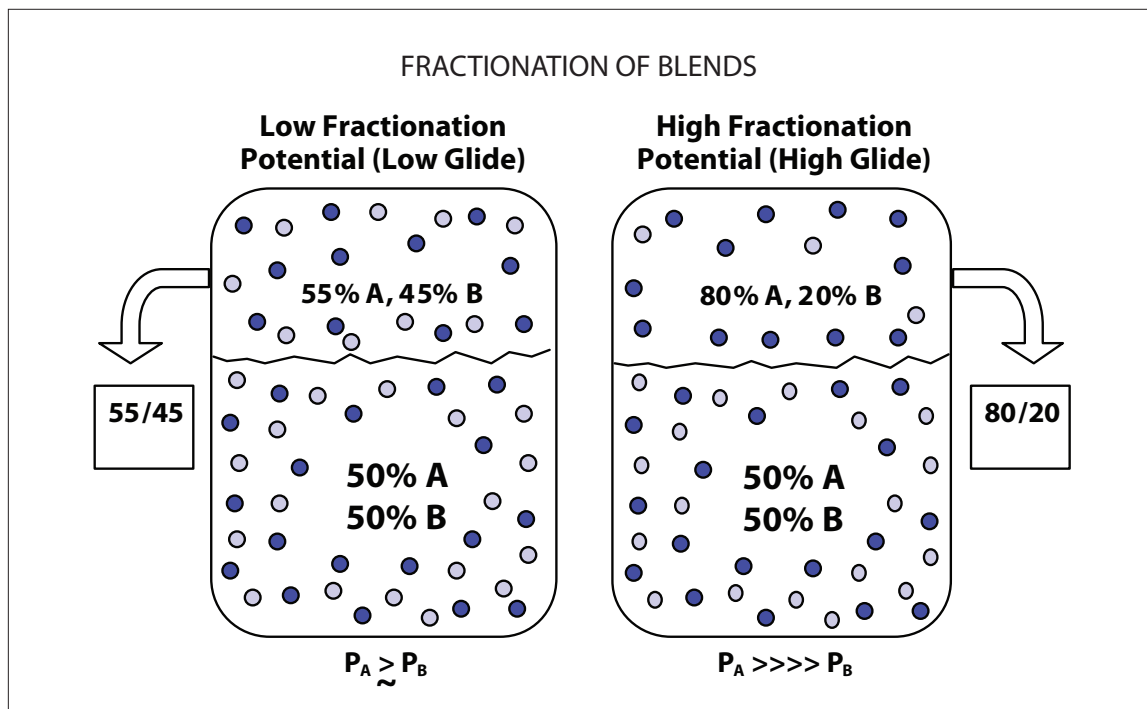

When vapor is removed from a cylinder or system containing a zeotropic blend, two things are going to happen: 1) the vapor being removed is at the wrong composition, so it will have more of the higher pressure/higher capacity refrigerant component; and 2) the liquid that is left behind boils more of the higher pressure component out of the liquid to replace the vapor. Eventually, the liquid composition changes because more of the A component leaves the container or system compared to the bulk liquid composition.

Fractionation is the change in composition of a blend because one (or more) of the components is lost or removed faster than the other(s).

A large difference between the pressures of the starting components will cause a greater difference in the vapor composition compared to the liquid composition. This will worsen the effect of fractionation on that blend. The High Fractionation Potential blend shown above will produce a vapor composition of 80% A and 20% B above the liquid composition of 50/50.

Molecules will transfer back and forth to the vapor at a similar rate when the pressures of the individual components are close to each other. The Low Fractionation Potential blend shown above will have a very similar vapor composition compared to the liquid. In this case, it will take a long time to noticeably change the liquid composition away from 50/50.

Temperature Glide will be higher for High Fractionation blends, and lower for Low Fractionation blends.

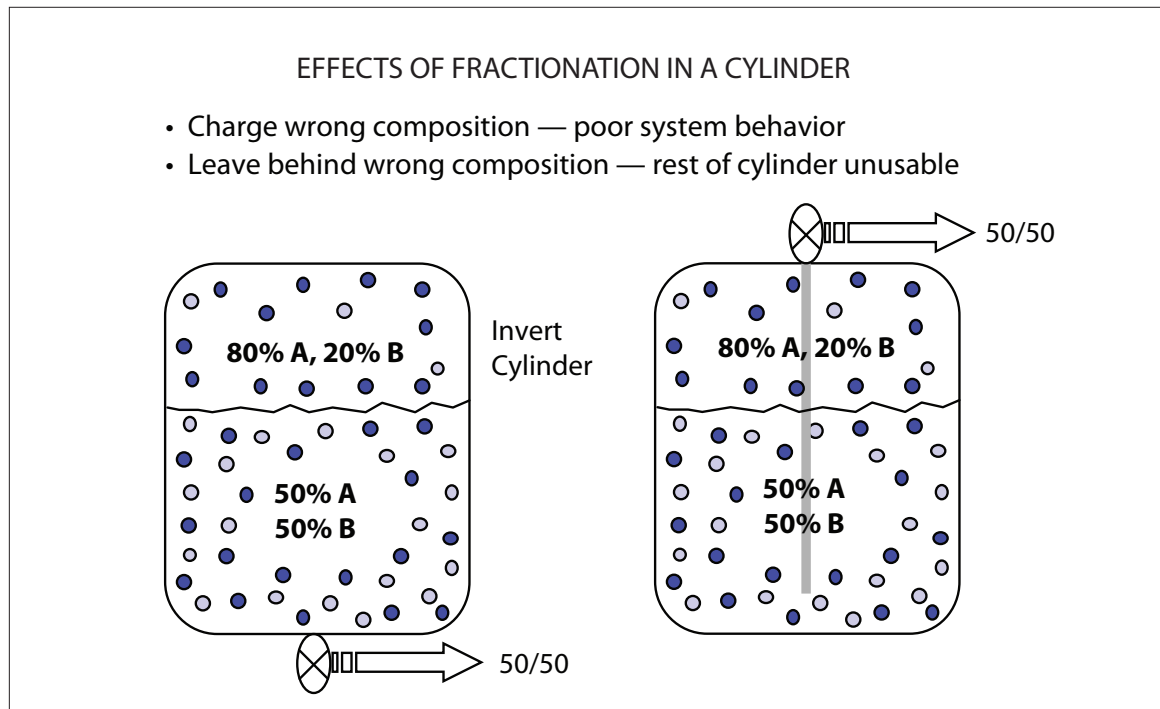

To avoid charging the wrong composition and fractionating the remaining blend, zeotropic blends must be removed from the cylinder as a liquid. This can be done by turning the cylinder over so the valve is on the bottom. For larger cylinders with two valves, use the 'liquid' valve. Liquid refrigerant will come up through a dip tube to the valve.

** All refrigerant suppliers have removed dip tubes in their 24 lb. to 30 lb. packages. Check the box or cylinder label for instructions on which side should be up for liquid removal.*

"Liquid charging" does not mean that liquid refrigerant should be pushed into the suction line of the system, allowing it to slug the compressor. After the initial charge into the high side of a system, the technician should start the compressor and complete the charging process by flashing the refrigerant from liquid to vapor in the charging hose or across specially designed valves. Any method that allows the refrigerant to go to vapor before it hits the compressor should work. Generally, the refrigerant needs to be added slowly at this point.

Please note:

When liquid and vapor are together in a cylinder or in a system, **it is always the vapor that will be at the wrong composition.**

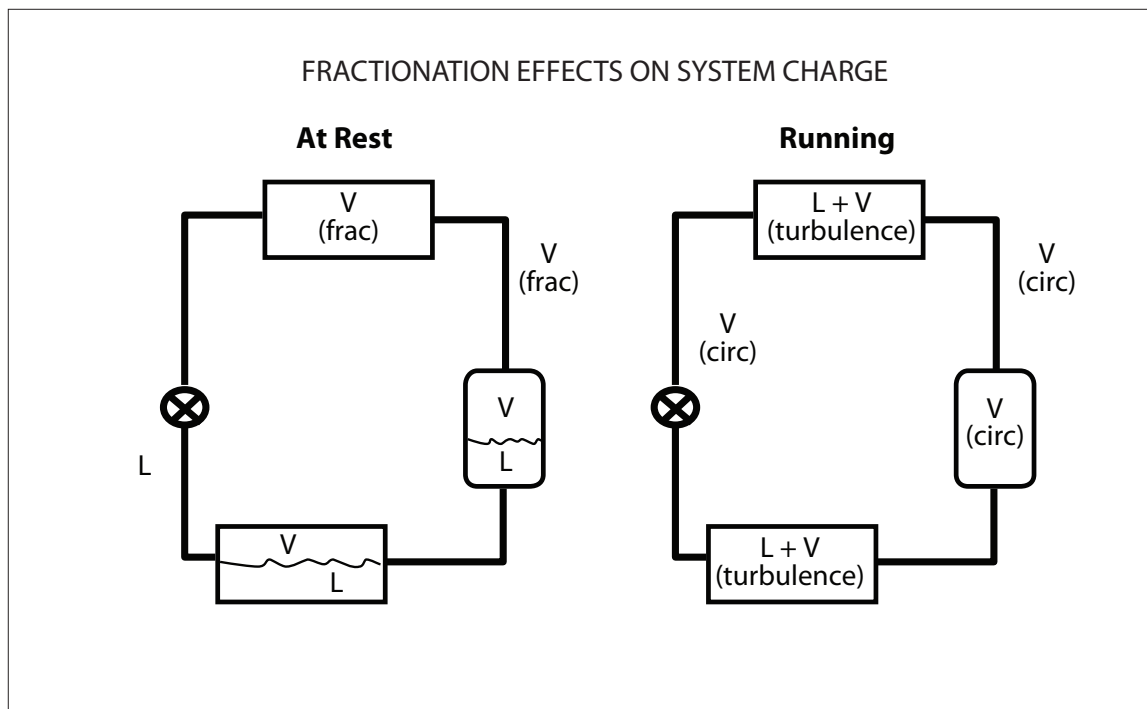

A system **at rest** will allow the refrigerant to pool and the vapor to come to an equilibrium concentration above the liquid. Leaks that occur in vapor areas of the equipment will fractionate the blend. The worst case will occur when about half of the refrigerant charge has leaked. Small amounts leaked from a system will not change the remaining blend by much. Large leaks will shift the composition, but the majority of the pounds after recharge will be from fresh product at the correct composition.

Recharging the system after repair will result in a blend with slightly reduced capacity and operating pressures. In smaller systems, where charge size is critical, it is best to recover any remaining refrigerant and charge with fresh blend. In larger systems, you will need to make a decision whether the remaining charge should be recovered or not. Note: for Low Fractionation Potential blends you will not see much shift in composition anyway, and therefore the charge can be topped off after repair without loss of properties.

In **running systems** it has been found that the circulating composition is the original blend composition. In liquid and suction lines there is no second phase, and in the heat exchangers there is much turbulence so leaks will lose both vapor and liquid. Testing has shown that leaks from a running system do not cause fractionation, and a normally cycling system will not fractionate much during the off cycle.

In other words, in most refrigeration applications, servicing systems with blends does not require full recovery of the charge. After repair, most systems can be topped off with the blend. In most air conditioning systems, however, a leak during the off season will likely require a full change of refrigerant charge.

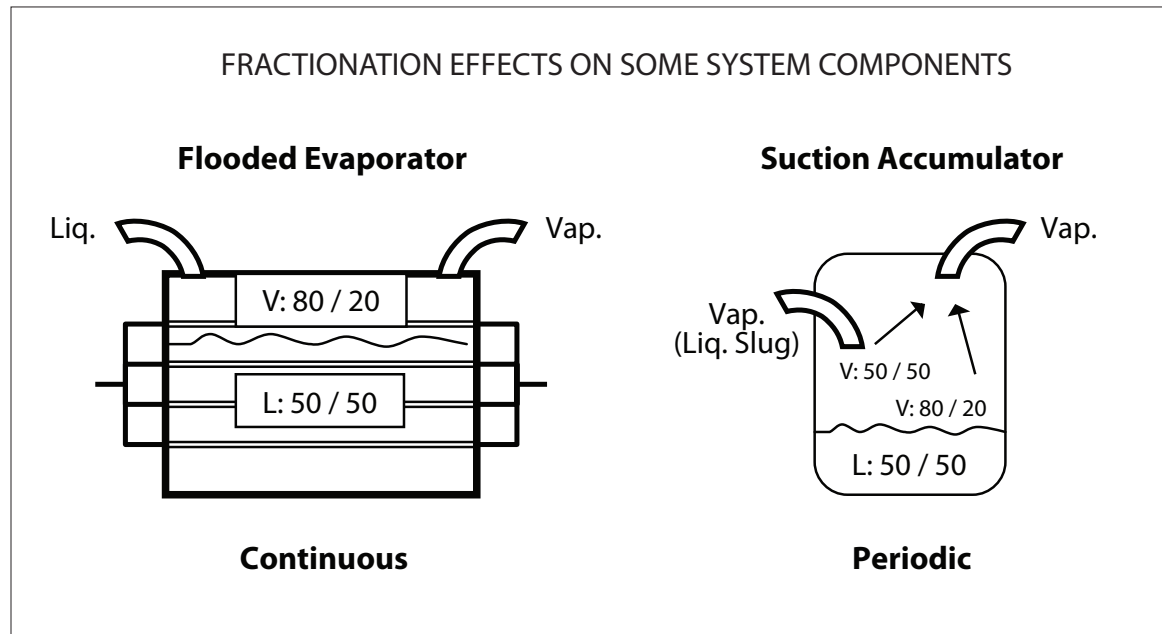

Flooded Evaporators are designed to keep a pool of boiling liquid refrigerant surrounding a bundle of tubes. The water, brine, or product to be cooled flows through the tubes. The vapor that boils off this pool is returned to the compressor, condensed, and then poured back into the pool.

In the case of zeotropic blends, the vapor that boils off this pool of refrigerant will be at the fractionated composition. If the properties at this composition differ significantly from what the compressor expects, then the system could develop high head pressures, high amperage draw at the compressor, reduced cooling effectiveness (capacity) in the evaporator, etc. Normally the use of blends in this type of system is not recommended.

Suction Accumulators are placed in the suction line before the compressor to keep liquid from flowing into the compressor. The liquid slug is trapped in the accumulator where it can boil off to vapor, combining with other suction gas. Zeotropic blends will fractionate in the accumulator, giving a short-lived spike of higher-pressure vapor back to the compressor.

Systems with suction accumulators should not be overcharged with the expectation that the accumulator will protect the compressor. (This may lead to frequent pressure spikes.) Also, this type of system should never be charged by dumping liquid refrigerant into the suction line and allowing it to vaporize in the accumulator. (High pressure trips may occur.)



Let's assume that a blend of 50% A refrigerant and 50% B refrigerant flows across a valve into an evaporator coil. If we follow a small "piece" of the blend as it flows along the tube we can see the effect of fractionation:

1. At the beginning of the tube the blend is mostly liquid with a few bubbles in it. The liquid composition is 50/50 and the boiling point is (for purposes of discussion) 40°F.
2. As the "piece" of refrigerant marches along the tube, more liquid is boiled to vapor. Since A transfers to vapor faster than B, a larger proportion of A (than B) is transferred to vapor. This makes the composition of the liquid change along the length of the tube. In this example, the "piece of blend" which started at 50/50, now has a liquid composition at 37% A and 63% B. (The vapor has the extra A – at 65%.) The important point is that the boiling temperature of the current liquid composition is now about 45°F.
3. When our "piece" of the blend gets to the end of the evaporator it is now almost all vapor. This vapor contains almost all of the refrigerant that we started with at the beginning of the tube, so the composition is almost back to 50/50. The last few remaining drops are now concentrated in the B component (about 75% in this example). The boiling point of this liquid composition is now about 50°F.

Overall Temperature Glide: The difference in temperature between the Saturated Vapor blend at the end of the evaporator and the liquid entering the evaporator is 50°F-40°F = 10°F.

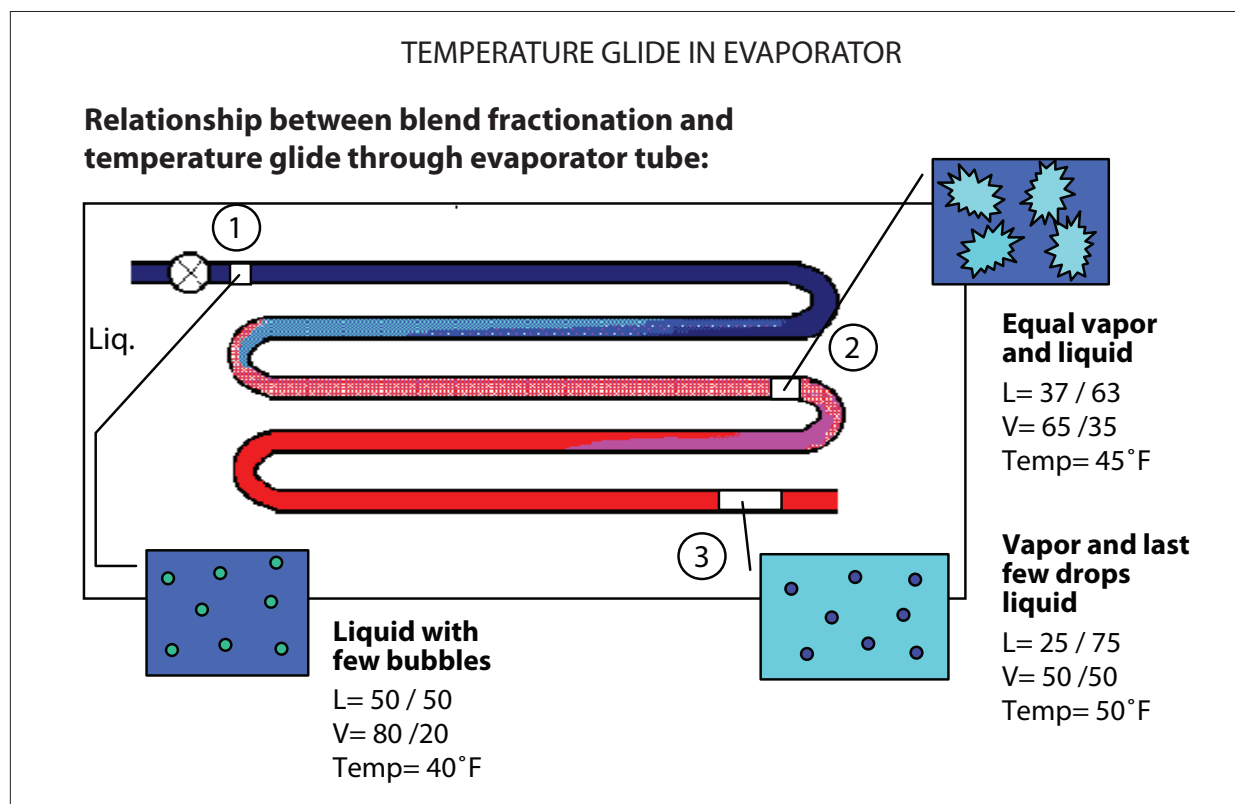



For pure refrigerants, the evaporator coil is at a constant temperature throughout. For blends, however, the temperature glide causes the tubing to be at different temperatures.

If you stand back and blow a fan across the evaporator coil, the air that blows out the other side looks like it saw an average temperature. Part of the evaporator is colder, and part is warmer, but the air mixes and generally gives the equivalent house or box temperature as if it passes over a constant temperature coil at this average. There are, however, some potential problems that can occur:

- The colder part of the coil may form frost faster than an equivalent coil at constant temperature.
- The warmer part of the coil may cause “hot spots” in the case or cold box, affecting product quality.
- Temperature control sensors located in hot or cold spots may affect cycle times.
- Ice machines will produce thicker ice on the bottom of the plate and thinner ice at the top.
- TXV sensor bulbs located at the outlet of the evaporator will now see warmer gas.

Generally the temperature glide does not affect the system’s ability to remove heat from the air or from product, but the glide will probably affect some of the system’s controls. Superheat settings and pressure controls will be discussed further.

Frost formation and hot or cold spots must be addressed “outside” the refrigeration loop (defrost strategies, product placement, etc.). Making the whole coil warmer or colder will change the overall air or box temperature, not solve the glide-related problem.

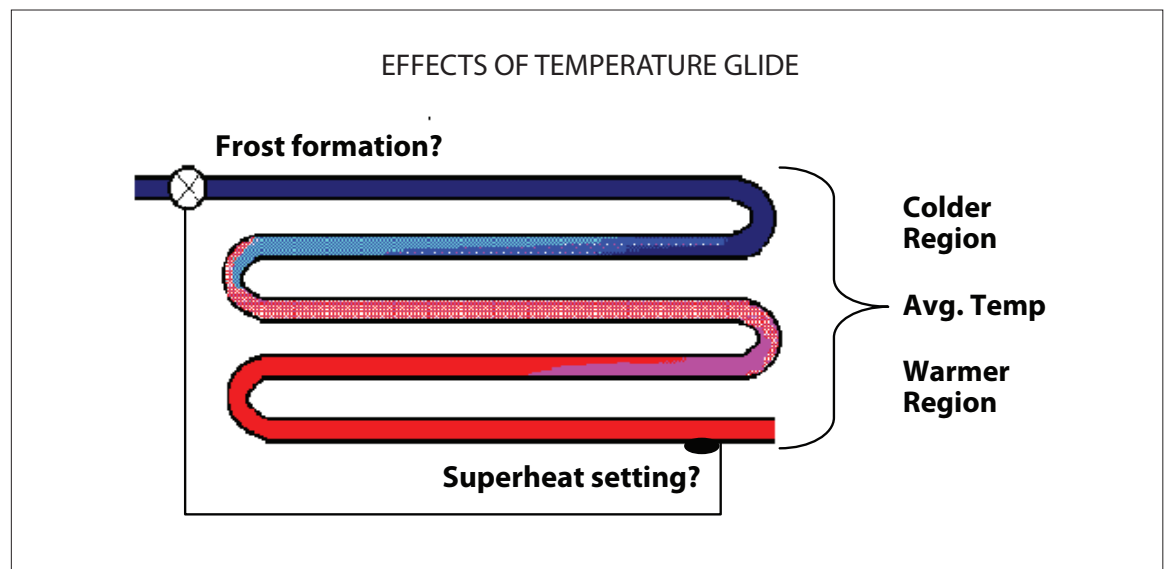

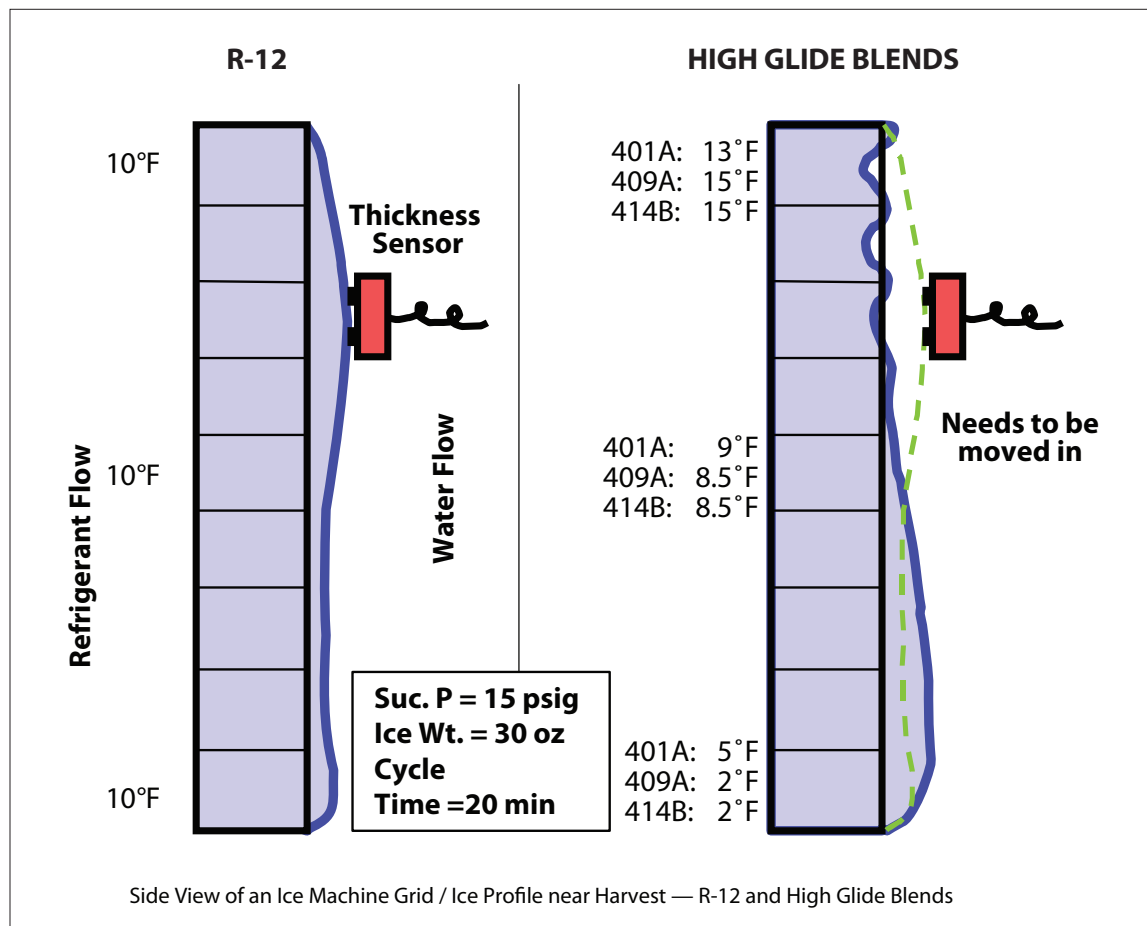

ICE MACHINE TEST RESULTS

Various R-12 retrofit blends were tested in an R-12 ice machine. The picture above represents a side-view of the plate as the water freezes.

For R-12, the water froze in a nearly constant thickness all the way down the plate. The evaporator, mounted on the back side of the plate, held a constant 10°F along the entire length. The ice thickness sensor was located at about row 3.

For each of the blends tested, R-401A, R-409A and R-414B, the glide of the blend caused the lower portion of the plate to be from 8°F to 13°F colder than the upper portion of the plate. The top rows did not fill in as quickly as the bottom, and the overall ice bank that formed was weighted more towards the lower portion of the plate.

The ice machine was still operating at the same suction pressure and was generating the same 30 ounces of ice every 20 minutes. The biggest difference was the setting of the thickness sensor. For the first run, the machine did not shut off because the ice surface near the 3rd row was not forming as fast as the lower portion of the plate. When the sensor was adjusted inward to take this into account, the machine ran fine.

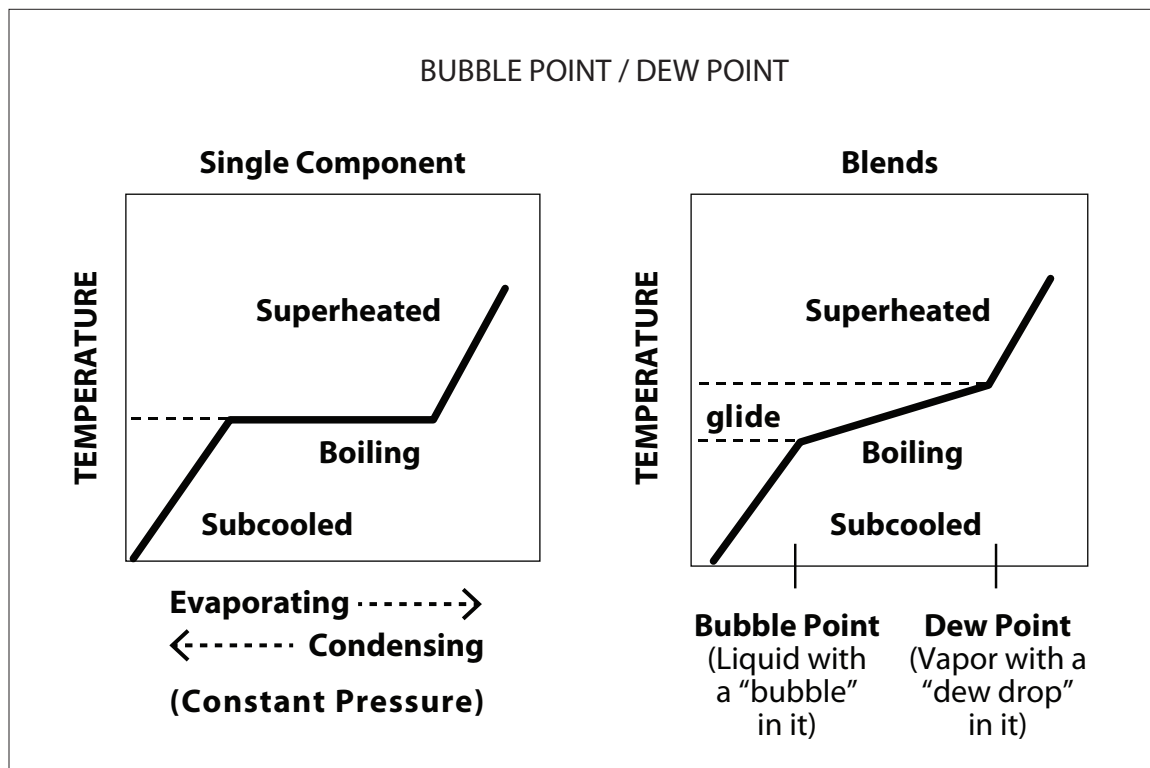

The process of phase change (boiling or condensing) is the same for blends as it is for pure refrigerants:

Boiling: liquid reaches a temperature where bubbles form and then the liquid boils to vapor. When the last drops of liquid disappear, any additional heat input causes the vapor to superheat.

Condensing: vapor cools to a temperature where liquid drops start to form, then the vapor condenses to liquid. When the last of the vapor disappears, any additional removal of heat causes the liquid to subcool.

When these phase changes occur in a pure refrigerant, at constant pressure, the temperature stays constant at what we normally call the "boiling point". For blends the process is the same but, the shift in composition during phase change causes the temperature glide to occur. The vapor will still superheat and the liquid will still subcool; however, the Saturated Vapor temperature and the Saturated Liquid temperature are now the temperatures at the ends of the temperature glide for a given pressure.

Saturated Liquid = Bubble Point (Liquid with bubbles starting to form)

Saturated Vapor = Dew Point (Vapor with dew drops starting to form)



TWO-COLUMN PT CHARTS

- **Traditional PT Charts**

- Temperature in left column, pressure in the remaining columns
- Saturated pressure listed — same for boiling or condensing / saturated liquid or vapor

- **New Blends Need Two Columns**

- Zeotropic blends have different temperatures for saturated liquid and saturated vapor at constant pressure
- Bubble Point (or Liquid) gives pressure for saturated liquid; used as the reference point for subcooling calculations
- Dew Point (or Vapor) gives pressure for saturated vapor; used as the reference point for superheat calculations

Temperature		R22		R407C		U F
°F	°C	Liquid Point	Vapor Point	Liquid Point	Vapor Point	
-40	-40.0	0.5	3.0	4.4	4.4	
-35	-37.2	2.6	5.4	0.6	0.6	
-30	-34.4	4.9	8.0	1.8	1.8	
-25	-31.7	7.4	10.9	4.1	4.1	
-20	-28.9	10.1	14.1	6.6	6.6	
-15	-26.1	13.2	17.6	9.4	9.4	1
-10	-23.3	16.5	21.3	12.5	12.5	1
-5	-20.6	20.1	25.4	15.9	15.9	1
0	-17.8	24.0	29.9	19.6	19.6	2
5	-15.0	28.2	34.7	23.6	23.6	2
10	-12.2	32.8	39.9	28.0	28.0	3
15	-9.4	37.7	45.6	32.8	32.8	3
20	-6.7	43.0	51.6	38.0	38.0	3
25	-3.9	48.8	58.2	43.6	43.6	4
30	-1.1	54.9	65.2	49.6	49.6	5
35	1.7	61.5	72.6	56.1	56.1	5
40	4.4	68.5	80.7	63.1	63.1	6
45	7.2	76.0	89.2	70.6	70.6	6
50	10.0	84.0	98.3	78.7	78.7	7
55	12.8	92.6	108	87.3	87.3	8
60	15.6	102	118	96.8	96.8	9
65	18.3	111	129	106	106	9
70	21.1	121	141	117	117	1
75	23.9	132	153	128	128	1
80	26.7	144	166	140	140	1
85	29.4	156	180	153	153	1
90	32.2	168	195	166	166	1
95	35.0	182	210	181	181	1
100	37.8	196	226	196	196	1
105	40.6	211	243	211	211	1
110	43.3	226	261	229	229	2
115	46.1	243	280	247	247	2
120	48.9	260	300	266	266	2
125	51.7	278	321	286	286	2
130	54.4	297	342	307	307	2
135	57.2	317	365	329	329	2
140	60.0	337	389	353	353	3
145	62.8	359	-	-	-	
150	65.6	382	-	-	-	

Pressure-Temperature (PT) charts traditionally have listed the temperature in the left column and pressures for various refrigerants in the remaining columns. For blends, we now need two columns per refrigerant: one for Vapor Pressures and one for Liquid Pressures.

Note: You should not read a PT chart across — heat exchangers run at constant pressure, not constant temperature.

Superheat Setting: the process for obtaining superheat is the same as it has always been — measure the temperature on the suction line, for example, at the TXV bulb. To find the saturated vapor temperature you measure the suction pressure, and then refer to the PT chart for the corresponding temperature. For blends you must use the Vapor (Dew Point) column. Subtract the saturated temperature from the measured temperature to get the amount of superheat.

Subcooling: the process for obtaining subcooling is also the same as it has been — measure the temperature of the line at the point of interest. To find the saturated temperature of the liquid you measure the pressure on the condenser, and then refer to the PT chart for the corresponding temperature. For blends you must use the Liquid (Bubble Point) column. Subtract the measured value from the saturated value to get degrees of subcooling.

Keep in mind the state of the refrigerant (liquid or vapor) where the measurement is being taken to determine which column you need to use. Also keep in mind that the only practical place that you find saturated vapor, at the correct composition, is at the end of the evaporator when measuring superheat.

Do not use the vapor column when liquid is present, since the vapor is at the wrong composition.



Assume a refrigeration system has been retrofitted from a single component refrigerant to a blend with a temperature glide of about 10°F. The blend will run with an average evaporator temperature that matches the constant evaporator temperature of the refrigerant that was replaced. About half of the glide is making the front of the evaporator colder, and the other half of the glide is making the back of the evaporator warmer. The outlet is about 5°F warmer than it used to be.

The TXV bulb has not been adjusted, and it was initially set for 7°F superheat above the saturated temperature of the original refrigerant. With the blend, the same average evaporator temperature is achieved — but now this only provides 2°F of superheat above the blend’s vapor temperature.

If the safety margin provided by the superheat setting is reduced too far, it is possible that the refrigerant may flood back to the compressor. In many cases, reducing the superheat by 4°F or 5°F may not be a problem, but, it is always a good idea to check the superheat to make sure.

Some R-12 retrofit blends have as high as 14°F glide — enough to completely overcome an original superheat setting of 7°F. Many of the current R-22 retrofit blends have temperature glides from 5°F to 10°F.

See pages 96-98 for a more detailed discussion of TXV operation after retrofitting.

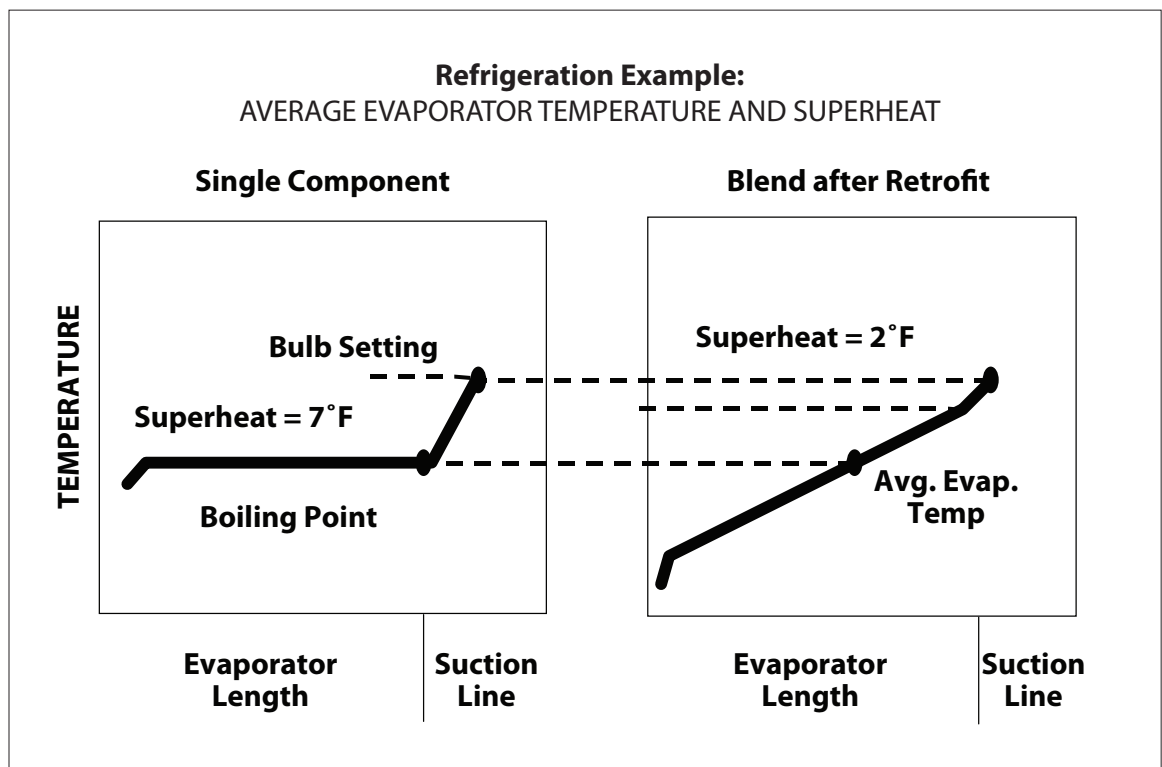



For air conditioning, the effects of temperature glide will be somewhat less severe. Using the same blend with a 10°F glide, this example looks at the effects of temperature glide using typical superheat settings for an air conditioner (10°F to 15°F).

The blend will run with an average evaporator temperature that matches the constant evaporator temperature of the refrigerant that was replaced. About half of the glide is making the front of the evaporator colder, and the other half of the glide is making the back of the evaporator warmer. The outlet will be 5°F warmer than it used to be.

The TXV bulb has not been adjusted, and it was initially set for 15°F superheat above the saturated temperature of the original refrigerant. With the blend, the same average evaporator temperature is achieved — but now the superheat drops to 10°F.

For most running conditions this should not be an immediate problem; however, air conditioners are critically charged to cover the worst case scenario of a hot day and cool house. In this case, the refrigerant is in danger of flooding back from the evaporator so correct superheat settings will be important. If the valve is adjustable, then superheat should be increased to compensate for the glide. If not, the system should be charged with slightly less refrigerant than the indicated amount.

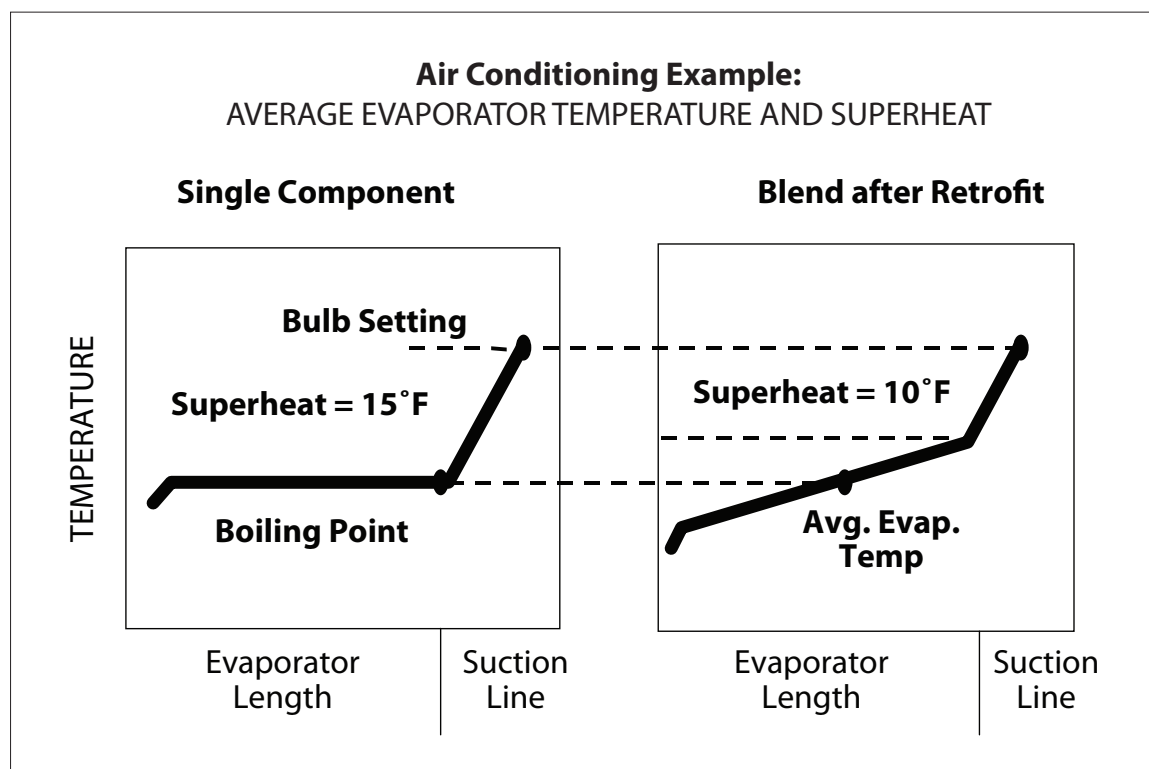



With R-12, a Cut In/Cut Out Pressure Control works as follows:

- The R-12 coil gets down to about 10°F and the pressure is about 15 psig. This means the box temperature is somewhere in the 20's °F. The pressure switch knows the box is cold enough and it turns off the compressor.
- Liquid R-12 pools in the evaporator coil and warms up to box temperature. As the box warms to about 38°F, the R-12 in the coil generates 35 psig and the pressure switch turns the system on again.

With the R-12 Retrofit Blends, the control works similarly:

- The average blend coil temperature gets down to about 10°F at about 15 to 16 psig (depending on the blend). The box temperature is about the same as it was with R-12, and the pressure switch shuts off the system.
- The blend in the *liquid state* settles in the coil and warms to box temperature. The blends have higher liquid pressures than R-12 - if no adjustment is made, the pressure switch will kick the system back on at 35 psig. For R-401A, this happens at 29°F; for R-409A it is 27°F; and for R-414B it is 28°F. Most of the blends will turn the system on too cold, and short cycling will cause the system to freeze up.

You will need to check the liquid pressure at 38°F and reset the cut in pressure accordingly. (Note: the vapor is at the wrong composition; do not use the vapor column.)

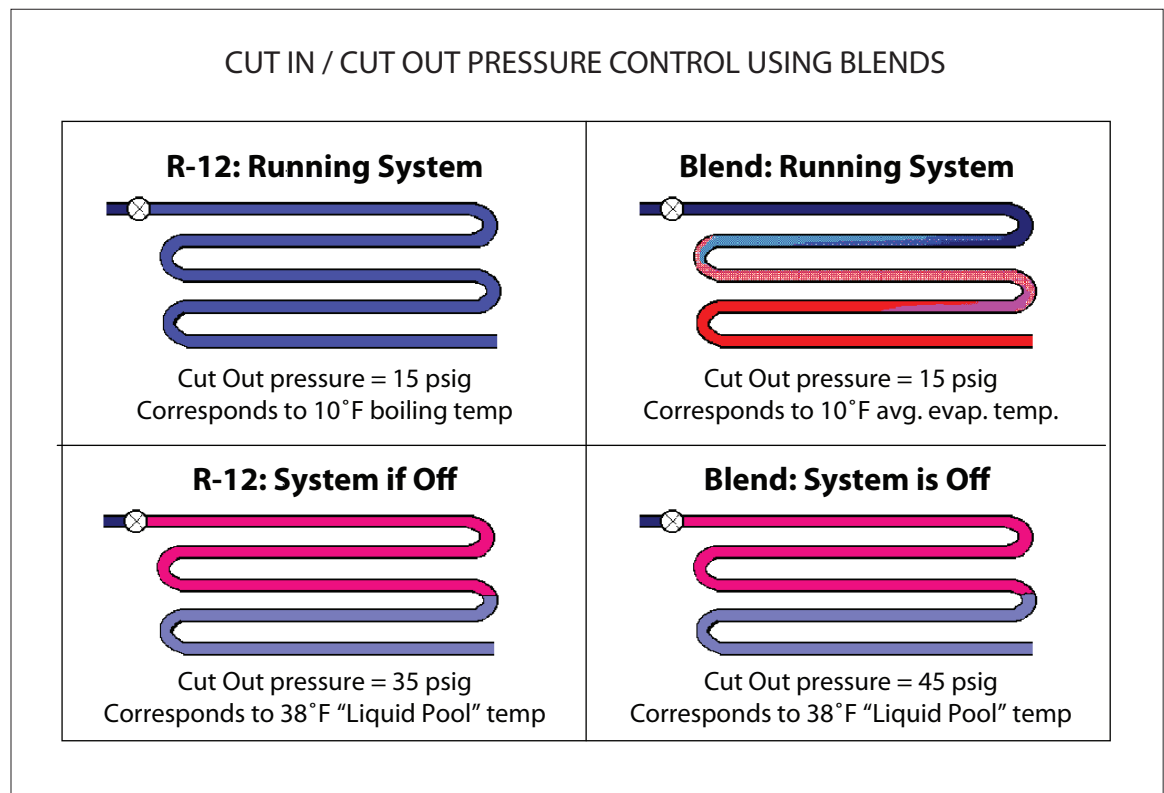

**R-12 REPLACEMENT REFRIGERANTS PROPERTY COMPARISON**

REFRIGERANT	COMPONENTS	COMPOSITION	GLIDE	LUBE	PRESSURE OF REFRIGERANT (PSIG) AT			
					-20°F	10°F	40°F	90°F
R-12	(pure)	100	0	M	0.6	15	37	100
R-134a	(pure)	100	0	P	4" vac	12	35	104
REFRIGERATION BLENDS								
R-401A	22 / 152a / 124	53 / 13 / 34	8	M A P	1	16	41	115
R-401B	22 / 152a / 124	61 / 11 / 28	8	A P	2	19	46	124
R-409A	22 / 124 / 142b	60 / 25 / 15	13	M A P	0	15	39	116
AUTOMOTIVE BLENDS								
R-414B	22 / 600a / 124 / 142b	50 / 1.5 / 39 / 9.5	13	M A P	0	14	37	105
R-417C	125 / 134a / 600	19.5 / 78.8 / 1.7	6	M A P	1	17	44	132

M: Mineral Oil A: Alkylbenzene P: Polyolester

R-134a: At first look, R-134a pressures match R-12 pretty well, but other properties show that R-134a needs larger equipment to perform the same job (higher compressor displacement and more surface area in the condenser). In effect, R-134a in an R-12 system has lower capacity and higher discharge pressures than expected. In addition, it requires POE flushing to remove mineral oil during a retrofit.

R-401A and R-401B: These are R-22-based blends that tend to have higher temperature glide. The presence of R-152a, an HFC, hurts miscibility with mineral oil. It is recommended to change some of the mineral oil to alkylbenzene unless it is a hermetic system running at warmer temperatures. R-401A matches R-12 capacity at around 20°F evaporator; warmer conditions will begin to show effects from being over-capacity (higher amperage draw, shorter cycle times). R-401B offers a boost in capacity at lower temperatures (-30°F). R-401B also matches R-500 performance in air conditioning equipment and dehumidifiers.

R-409A: This R-22-based blend has higher temperature glide. It has moderate miscibility with mineral oil, and generally offers good oil return in systems down to 0°F evaporator. R-12 capacity match is about 10°F and it still works well at lower evaporator temperatures. Higher discharge temperatures and pressures can develop, especially in warmer applications.

R-414B: This R-22-based blend has been formulated to keep the head pressure down. It is approved for automotive applications, although nylon barrier hoses and special fittings are required. In refrigeration equipment there may be a drop in capacity at colder temperatures (below 0°F).

R-417C: This HFC-based blend can be used in any original R-12 system as a retrofit blend for HCFC-based blends. Oil return is helped by the addition of a hydrocarbon additive. This will not cause the refrigerant to mix with the oil, however, and addition of polyolester lubricant may be required to ensure complete circulation of mineral oil.



R-407A and R-407C: Both products have the closest capacity and run-time property match to R-22. All products will have lower discharge temperatures than R-22. R-407A is a closer match at lower application temperatures, such as in commercial refrigeration applications. R-407C will work better in medium temperature and air conditioning applications. Replacement of mineral oil with polyolester (POE) is recommended.

R-422B and R-422D: These blends will have lower capacity than R-22 in the same system, and in many cases there will be an increase in pressure drop that may require changing TXVs or distributors. They contain hydrocarbons that will help circulate mineral oil in smaller systems. Larger systems, especially ones with receivers, will need addition of POE to help keep the mineral oil from being stranded.

R-404A and R-507: These blends can be used to retrofit R-22 systems that would otherwise be able to run R-404A, such as in commercial refrigeration applications. TXVs would need to be changed to the appropriate R-404A model. Discharge pressures would also increase, although discharge temperatures would come down. An oil change to POE is also required

R-422C: This blend can be used to retrofit low temperature R-22 systems. The performance characteristics (pressure/temperature) will look much like R-404A, but with a drop in capacity of up to 10%. The hydrocarbon additive will help circulate mineral oil around the system. In larger systems, however, some oil holdup may occur in the receiver. Addition of POE will solve this problem.

R-22 REPLACEMENTS FOR REFRIGERATION AND AIR CONDITIONING

REFRIGERANT	COMPONENTS	GLIDE	LUBE	PRESSURE OF REFRIGERANT (PSIG) AT				
				-20°F	10°F	40°F	110°F	130°F
R-22	22	0	MA	10	33	68	226	297
LOOK-ALIKE BLENDS								
R-407A	32 / 125 / 134a	10	P	12	37	78	259	343
R-407C	32 / 125 / 134a	10	P	10	34	71	245	324
R-422B	125 / 134a / 600a	5	M A P	8	30	65	221	292
R-422D	125 / 134a / 600a	5	M A P	10	34	71	238	313
R-404A (507)	125 / 143a / 134a	1.5	P	16	44	86	271	355
R-422C	125 / 134a / 600a	4.5	M A P	16	43	86	273	356
NEW ONLY								
R-410A	32 / 125	0.2	P	27	62	118	365	476

M: Mineral Oil A: Alkylbenzene P: Polyolester



R-402A and R-402B: R-402A shows higher discharge pressures than R-502; however, the discharge temperature is lower. R-402B is a closer match in pressure, but the discharge temperature runs higher (this is good for ice machines, which is where R-402B is primarily used). Although a hydrocarbon is added to improve oil circulation, it is still recommended to replace some mineral oil with alkylbenzene oil.

R-408A: R-408A has the closest PT match to R-502 across the whole application range. It also has very low temperature glide. R-408A does generate higher discharge temperatures than R-502, and this could be a problem in extreme application conditions, such as transport refrigeration in hot climates. R-408A can be used in most refrigeration systems.

R-404A and R-507: These two blends are virtually the same in terms of operation and equipment. In a retrofit situation, they will require POE flushing to be performed. They will also generate higher discharge pressures. Generally speaking, retrofitting with these HCFC blends will add more complexity and cost to a retrofit job, especially when compared to using one of the other blends.

R-422C: This blend is a direct HFC retrofit blend for R-502 and can be used to replace HCFC-based blends previously used to retrofit R-502 systems. The performance characteristics (pressure/temperature) will look much like R-404A, but with a drop in capacity of up to 10%. The hydrocarbon additive will help circulate mineral oil around the system. In larger systems, however, some oil holdup may occur in the receiver. Addition of POE oil will solve this problem.

R-502 REPLACEMENT REFRIGERANTS PROPERTY COMPARISON

REFRIGERANT	COMPONENTS	COMPOSITION	GLIDE	LUBE	PRESSURE MATCH			
					-20	10	40	90°F
R-502	22 / 115	49 / 51	0	M A	15	41	81	187
HCFC BLENDS								
R-402A	125 / 290 / 22	60 / 2 / 38	2.5	M + A P	19	48	93	215
R-402B	125 / 290 / 22	38 / 2 / 60	2.5	M + A P	15	42	83	198
R-408A	125 / 143A / 22	7 / 46 / 47	1	M + A P	14	38	77	186
HFC BLENDS								
R-404A	125 / 143A / 134a	44 / 52 / 4	1.5	P	16	48	84	202
R-507	125 / 143A	125 / 143a	0	P	18	46	89	210
R-422C	125 / 134a / 600a	125 / 134a / 600a	5	M A P	18	44	87	205

M: Mineral Oil A: Alkylbenzene P: Polyolester



System Identification

LOCATION			
ADDRESS			
REFRIGERANT CHARGE / TYPE			
LUBRICANT CHARGE / TYPE			
COMPRESSOR MODEL (S)			
CONDENSER MODEL (S)			

For larger systems: Fill in overall system data then use subsequent charts for case/evaporator run data.

For small systems: Use subsequent tables - one row for each system retrofit.

For distributed or stand-alone systems: Reference individual condensing unit(s) in the following tables.

NOTES:

Additional copies of page 90 and 91 are available in NRI's R-22 Retrofit Guideline and Procedures Handbook.



System Data Collection

SYSTEM / CASE NUMBERS								
CONDENSING UNIT MODEL								
EVAPORATOR MODEL								
	Before Retrofit	After Retrofit	Before Retrofit	After Retrofit	Before Retrofit	After Retrofit	Before Retrofit	After Retrofit
EXPANSION DEVICE								
AMBIENT TEMPERATURE / RH								
SUCTION TEMPERATURE								
SUCTION PRESSURE								
CONDENSER PRESSURE								
CASE/BOX TEMPERATURE								
SUPERHEAT SETTING								
SUBCOOLING SETTING								
SIGHT GLASS APPEARANCE								

SYSTEM / CASE NUMBERS								
CONDENSING UNIT MODEL								
EVAPORATOR MODEL								
	Before Retrofit	After Retrofit	Before Retrofit	After Retrofit	Before Retrofit	After Retrofit	Before Retrofit	After Retrofit
EXPANSION DEVICE								
AMBIENT TEMPERATURE / RH								
SUCTION TEMPERATURE								
SUCTION PRESSURE								
CONDENSER PRESSURE								
CASE/BOX TEMPERATURE								
SUPERHEAT SETTING								
SUBCOOLING SETTING								
SIGHT GLASS APPEARANCE								

Additional copies of page 90 and 91 are available in NRI's R-22 Retrofit Guideline and Procedures Handbook.



R-22 Alternative Retrofit Guidelines

General Considerations:

- **Seals and O-Rings.** R-22 and mineral oil interact with many elastomers causing some swelling, which actually helps complete the intended seal. There is also a measurable increase in hardness over time. One consequence of this process, however, is that during a retrofit away from R-22, the new refrigerant/oil combination may cause the seal to shrink and allow leakage. Any process that disturbs the seating of the gasket, such as depressing Schrader valves or operating ball valves, may also cause leaks to occur. Therefore, for any retrofit job it is recommended to change Schrader valve cores, o-rings on caps, elastomeric seals, and any seals found to be leaking before the retrofit takes place.
- **TXVs.** Some refrigerants will have very similar run-time capacity and pressure drop across a TXV while others may be different enough from R-22 that the valve will appear undersized. The proper sizing of valves should be checked with manufacturer's data for the given application and anticipated run conditions. In some cases, TXVs should be replaced with the proper size valve for the refrigerant chosen. Superheat settings should be checked and/or adjusted since the original settings might be affected by the temperature glide of the new blend (see Sizing TXVs, pages 96-98).
- **Capillary Tubes.** Smaller systems with capillary tubes may not perform the same when retrofitted. Unless the length of the tube is adjusted to match the performance of the blend, the only other way to change the operation of a cap tube system is to adjust the refrigerant charge size.
- **Filter driers and/or cores** should be replaced during the retrofit process. The filter drier should be replaced with the same type currently in use in the system.
- **Temperature Glide/Fractionation.** Most of the retrofit blends have some degree of temperature glide. System operation can be affected (superheat settings, other controls) and fractionation must be considered for systems that may leak while not running for long periods. (see pages 71-86)
- **Pressure Controls.** Some refrigerant blends will run at different pressures than R-22 to achieve the same temperatures. Any pressure-related control should be adjusted to compensate for the different pressure.
- **Lubricant Issues.** In general, HFC blends will require the use of polyolester (POE) lubricant. Traditional retrofit guidelines call for the mineral oil to be below 5%. This is typically achieved by draining oil from the compressors and the oil management system and replacement with POE up to 3 times. Follow compressor manufacturer guidelines for recommended levels and procedures.

Some retrofit blends contain hydrocarbon additives to help circulate mineral oil with the HFC refrigerant. This strategy works well to thin the mineral oil and push it back along the suction line; however, the HFC/hydrocarbon blends still does not mix mineral oil on the high side of the system. If there is a receiver, mineral oil might pool on top of the refrigerant and hold up there. If oil return becomes a concern in flooded evaporators or the suction line accumulator acts as a low pressure receiver, manufacturer's recommendation is to add POE to help circulate MO in the system.

**PRODUCT-SPECIFIC ISSUES OR CONSIDERATIONS**

FROM	TO	SPECIFIC ISSUES OR CONSIDERATIONS
R-11	R-123	Follow chiller manufacturer's recommendations
R-12	R-134a	POE oil change; material compatibility; loss of performance at high ambient temperature
	R-401A/B	Possible change to AB oil at < 30°F; Temperature Glide; Use R-401B for lower temps
	R-409A	Good low temperature performance match; Temperature Glide
	R-414B	Good medium temperature performance match; Temperature Glide
	R-417C	HFC with HC additive — possible oil circulation issue requiring POE addition
R-13	R-23	Higher discharge temperature; POE change or same HC additive if required
	R-508B	Higher pressures; POE change or same HC additive if required
R-22	R-407A/C	Best performance match; POE required; Temperature Glide; -A better at low temperature
	R-422B/D	Better match in AC equipment, medium temp; possible pressure drop
	R-422C	Higher pressures, TXV change; All 422 — HC additive, may require POE addition
R-401A/B	R-417C	HFC retrofit; HC additive, may require POE addition if oil does not circulate
R-402A/B	R-422C	HFC retrofit; HC additive, may require POE addition if oil does not circulate
R-404A	R-422C	Lower GWP; HC additive, may require POE addition if oil does not circulate
R-408A	R-422C	HFC retrofit; HC additive, may require POE addition if oil does not circulate
R-409A	R-417C	HFC retrofit; HC additive, may require POE addition if oil does not circulate
R-414B	R-417C	HFC retrofit; HC additive, may require POE addition if oil does not circulate
R-500	R-134a	For larger chiller - loss of capacity/longer run times; POE change
	R-401A/B	Use R-401B for best match; Temperature Glide
	R-409A	Good match at higher application temps; Temperature Glide
	R-414B	Loss of capacity; Temperature Glide
	R-417C	HFC retrofit option; Loss of capacity; HC additive – may require POE addition
R-503	R-508B	Good match; POE change or same HC additive if required
R-507	R-422C	Lower GWP; HC additive, may require POE addition if oil does not circulate



General Retrofit Procedure for Large Refrigeration or AC Systems, or for a Planned Retrofit Project

1. Collect baseline data for operation of the system with existing refrigerant charge. Make note of any evaporators, display cases, or other system components that do not appear to be running properly and note any required repairs.
2. Leak check the system while still charged with the original refrigerant to identify any repairs needed during the retrofit process.
3. Disconnect electrical power to system and properly recover the refrigerant charge. Record the amount of refrigerant recovered.
4. Perform any required maintenance or repair operations previously identified, including:
 - replacement of seals and gaskets
 - replacement of Schrader cores and caps
 - leak repairs
 - filter drier replacement
 - compressor oil change or addition of POE to existing oil charge
 - replace TXV, TXV element, and/or refrigerant distributor nozzle as required
5. If desired, pressurize and leak check the system by preferred method. Evacuate the system down to desired micron level and confirm that it holds.
6. Charge the system with the right amount of the retrofit blend (from 85% to 100%, see charts on pages 9-10). Make sure the refrigerant is removed from the cylinder as a liquid.
7. Restart the system and allow it to come to normal operation conditions. Compare the new operation data to the original run time data. Adjust charge or equipment settings as needed.
8. Check superheat on the TXVs and adjust as necessary.

Note: the temperature glide of a blend will likely affect TXVs by showing a lower than expected superheat value. (see Blends Tutorial, pages 82-85)
9. Label the system with identification stickers showing the new refrigerant and oil charge.



General Retrofit Procedure for Small, Self-Contained Systems

1. If the system is still running, collect baseline data for operation of the system with the existing refrigerant. Make note of any obvious performance problems with the system.
2. If possible, leak check the system while still charged with the original refrigerant to identify any repairs needed during the retrofit process.
3. Disconnect electrical power to system and properly recover the original refrigerant charge.
4. Perform any repairs previously identified. In addition, all retrofit jobs should include the following:
 - replace Schrader cores and caps
 - add/replace filter drier
 - change oil if required (follow equipment manufacturer's guidelines), or add small amount of POE to improve oil circulation
5. If desired, pressurize and leak check the system by preferred method. Evacuate the system down to desired micron level and confirm that it holds.
6. Charge the system with the right amount of the retrofit blend (from 85% to 100% , see charts on pages 9-10). Make sure the refrigerant is removed from the cylinder as a liquid.
7. Restart the system and allow it to come to normal operation conditions. Adjust charge or settings as needed.
8. Check superheat on the TXVs and adjust as necessary.

Note: the temperature glide of a blend will likely affect TXVs by showing a lower than expected superheat value. (see Blends Tutorial, pages 82-85)
9. Label the system with identification stickers showing the new refrigerant and oil charge.



Sizing Thermostatic Expansion Devices (TXV)

Some refrigerants will have very similar run-time capacity and pressure drop across a TXV while others may be different enough from R-22 that the valve will become undersized. TXV capacity is determined by: (1) three system conditions: evaporator refrigerant saturation temperature, liquid refrigerant temperature entering the TXV and the pressure drop across the TXV port, and (2) thermodynamic properties of the refrigerant.

It cannot be assumed that the TXV capacity will remain the same after converting a R-22 system to an alternative refrigerant because in some cases the TXV capacity will be reduced when used with the alternative refrigerant. Since each refrigerant has its own pressure/temperature characteristics, some R-22 alternative refrigerants might require the use of a TXV with a R-404A thermostatic element. Regardless of whether the TXV is replaced, for maximum evaporator efficiency, the superheat should be checked and set to the equipment manufacturer's specification.

The nominal capacity of a Thermostatic Expansion Valve (TXV) is simply the capacity at the conditions it is rated. For high pressure refrigerants, such as R-22 or its alternatives, the AHRI industry standard rating point is: 40°F evaporator temperature, 100°F liquid temperature, and a 100 psi pressure drop across the TXV port. If any of these conditions change, the valve's capacity will also change.

Table 1 shows the capacities of a nominal 2 ton R-22 TXV when used with R-22, R-407A, and R-407C. Capacities are shown at varying evaporator temperatures, but in each instance the standard rating conditions of 100°F liquid temperature and a 100 psi pressure drop across the TXV port are used in conjunction with the various evaporator temperatures. *Note the highlighted nominal capacities for the three refrigerants listed and how they differ. This is the result of differing thermodynamic properties between the three refrigerants.*

TABLE 1 NOMINAL TXV CAPACITIES

VALVE TYPE	NOMINAL CAPACITY	REFRIGERANT														
		R-22						R-407A					R-407C			
		Recommended Thermostatic Charges														
		VC, VCP100, VGA			VZ, VZP			VC, VCP100, VGA			VZ, VZP40			NC, NCP100, NGA		
40°	20°	0°	-10°	-20°	-40°	40°	20°	0°	-10°	-20°	-40°	40°	20°	0°		
G	2	2.00	2.18	1.91	1.96	1.75	1.31	1.87	2.00	1.71	1.74	1.54	1.12	1.84	1.97	1.70

If a specific application is utilizing a liquid temperature or pressure drop across the TXV port which is different than the AHRI rating condition, the correction factors in **Table 2** and/or **Table 3** would be applied to the capacity listed in **Table 1** to determine the actual TXV capacity.

**TABLE 2** LIQUID CORRECTION FACTORS

VALVE TYPE	LIQUID TEMPERATURE ENTERING TXV ° F											
	0°	10°	20°	30°	40°	-50°	60°	70°	80°	90°	100°	110°
	Correction Factor, CF Liquid Temperature											
R-22	1.56	1.51	1.45	1.40	1.34	1.29	1.23	1.17	1.12	1.06	1.00	0.94
R-407A	1.75	1.68	1.61	1.53	1.46	1.39	1.31	1.24	1.16	1.08	1.00	0.92
	1.69	1.62	1.55	1.49	1.42	1.35	1.28	1.21	1.14	1.07	1.00	0.93

TABLE 3 PRESSURE DROP CORRECTION FACTORS

EVAPORATOR TEMPERATURE (° F)	PRESSURE DROP ACROSS TXV (PSI)											
	30	50	75	100	125	150	175	200	225	250	275	
	Correction Factor, CF Pressure Drop											
40°	.55	.71	.87	1.00	1.12	1.22	1.32	1.41	1.50	1.58	1.66	
20° & 0°	.49	.63	.77	.89	1.00	1.10	1.18	1.26	1.34	1.41	1.48	
-10° & -20°	.45	.58	.71	.82	.91	1.00	1.08	1.15	1.22	1.29	1.35	
-40°	.41	.53	.65	.76	.85	.93	1.00	1.07	1.13	1.20	1.25	

For example: An R-22 application, operating at +20°F is being retrofitted to R-407C. The evaporator capacity is 24,000 Btu/hr and the evaporator has a nominal 2 ton R-22 TXV installed. The application is designed to operate at 100°F condensing, with a 90°F liquid temperature.

The nominal capacity of the TXV for R-407C can be calculated as follows:

- » Nominal capacity at +20°F (from Table 1): 1.97 tons.
- » Corrected for liquid temperature at 90°F (from Table 2): $1.97 \times 1.07 = 2.10$ tons.

To determine the correct pressure drop across the TXV port, the difference between the corresponding pressures at the condensing temperature and evaporator pressure must be used:

- » $223 \text{ psi (100°F condenser saturation)} - 37 \text{ psi (20°F evaporator saturation)} = 186 \text{ psi}$.

The pressure drop through the refrigerant distributor and feeder tubes, the evaporator, and the frictional line loss in the piping between the condenser (where the pressure value is determined based on the condenser saturation temperature) and the TXV inlet must also be considered when determining the actual pressure drop across the TXV port.

For this example, we will assume the above mentioned pressure drop to be 36 psi.

- » The actual pressure drop across the TXV port will be:
 $186 \text{ psi} - 36 \text{ psi} = 150 \text{ psi}$.
- » Actual TXV capacity at the design condition for this application:
 $2.10 \text{ tons (corrected for liquid temperature)} \times 1.10 \text{ (from Table 3)} = 2.31 \text{ tons}$.
- » This would represent the TXV capacity at the design condition in the summer time.



To ensure that the TXV has sufficient capacity, a similar sizing exercise must be undertaken at the low ambient condensing temperature expected in the winter months. If the system utilizes fan cycling or head pressure control valves and fixes the minimum condensing temperature at 70°F (137.5 psi), the TXV capacity will also need to be considered at this condition.

For most applications the correction factors listed in **Table 4** can be used to determine if the existing R22- TXV will have sufficient capacity when used with the retrofit refrigerant of choice.

TABLE 4 CAPACITY MULTIPLIERS FOR R-22 ALTERNATIVE REFRIGERANTS

				REFRIGERANTS						
Evaporator Temp (°F)	Condensing Temp (°F)	Liquid Temp (°F)	R-22	CAPACITY MULTIPLIER*						
				R-417A	R-422B	R-422D	R-424A	R-438A	R-407A	R-407C
40	105	95	1.00	0.75	0.74	0.72	0.72	0.88	1.04	1.07
20	105	95	1.00	0.72	0.71	0.69	0.69	0.85	1.01	1.04
	70	60	1.00	0.82	0.83	0.83	0.83	1.00	1.20	1.22
0	105	95	1.00	0.69	0.68	0.66	0.66	0.81	0.98	1.00
	70	60	1.00	0.77	0.77	0.77	0.77	0.92	1.11	1.13
-20	105	95	1.00	0.67	0.66	0.64	0.64	0.79	1.96	0.97
	70	60	1.00	0.74	0.74	0.74	1.04	0.88	1.06	1.07

* Apply Capacity Multiplier to the TXV's R-22 rating to determine approximate TXV rating with the service retrofit replacement refrigerant. A total 40 psi pressure loss across the TXV from the refrigerant distributor and liquid line is assumed in the capacity multiplier calculation.

Thermodynamic data provided by NIST Refprop v8.0
Capacity and correction factors courtesy of Sporlan Division – Parker Hannifin



REFRIGERANT MANAGEMENT SERVICES

- 100 Analytical Testing Service
- 101 Request for Refrigerant Analysis
- 103 Request for Oil Analysis

PG: 105-113: RECOVERY, RECLAMATION, BANKING

- 105 Recovery Cylinder Hydro-Test & Refurbish Program
- 106 Refrigerant Recovery Containers
- 107 Instructions for Participating in NRI's Refrigerant Reclamation Program
- 109 EZ One-Shot™ Recovery Cylinder
- 111 Refrigerant Banking Program
- 112 Guidelines for Maximum Shipping Weights for Recovered Refrigerant Containers



Analytical Testing Service



National Refrigerants, Inc. Analytical Testing Service offers easy-to-use sample kits for:

- ❖ Refrigerant
- ❖ Refrigerant Oil
- ❖ Halon
- ❖ Specialty Testing/ GC-MS

Refrigerant: Testing to AHRI Standard 700 Specifications.
Refrigeration Oil: Testing oil quality as indication of system condition.
Halon Testing: Testing to Military/ASTM/ISO Specifications.

Sampling Kit Features

- Easy to use, single use, new sample cylinders
- High-pressure sample cylinder rated to 400 psig suitable for most alternative refrigerants and blends
- Instructions included for proper sampling procedures
- All analysis forms and necessary DOT labeling included
- Prepaid return postage to NRI's analytical laboratory for non-hazardous samples
- All analysis reports are returned with written commentary and recommendations
- Same day results available upon request for additional fee
- Sample cylinders available for very high pressure (VHP) refrigerants like R-508B and R-23

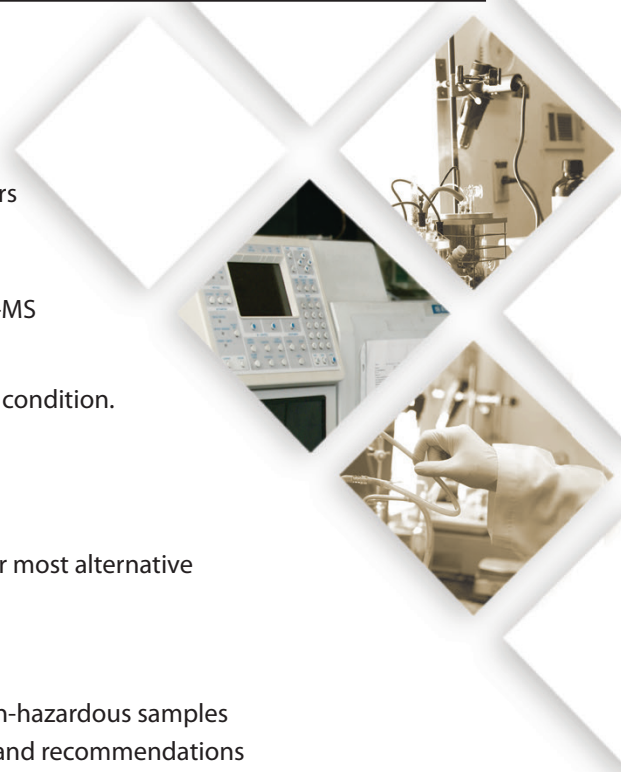

REFRIGERANTS	
PART NO.	DESCRIPTION
NRIHPN	High pressure refrigerant analysis
NRILP	Low pressure refrigerant analysis
Testing liquid phase to AHRI 700 Specifications for Fluorocarbon Refrigerants for one or more of the following:	
<ul style="list-style-type: none"> • IDENTIFICATION (Infrared Spectroscopy) • MOISTURE • ACIDITY • HIGH BOILING RESIDUE/OIL CONTENT • PARTICULATES/SOLIDS • PURITY (Gas Chromatography)/Impurity listing • CHLORIDE 	

NON-CONDENSIBLE GAS	
PART NO.	DESCRIPTION
NRINCN*	Non-Condensibile Gas in Vapor
Testing vapor phase to AHRI 700 Specifications for Fluorocarbon Refrigerants; (Requires a vapor-only sample taken from the source vapor phase)	
*Not applicable to R-11, R-113, R-123	

HALONS
Testing to MILITARY / ASTM / ISO Specifications

LUBRICANTS	
PART NO.	DESCRIPTION
NRIOA	Oil Analysis
Testing of lubricant for one or more of the following:	
<ul style="list-style-type: none"> • IDENTIFICATION (Infrared Spectroscopy) • MOISTURE / ACIDITY • APPEARANCE • VISCOSITY • METALS / ADDITIVES by ICP • RESIDUAL MINERAL OIL (as requested) • FLUORIDE, CHLORIDE and CONDUCTIVITY (as requested, extra cost) 	

LAB CAPABILITIES	
TESTS PERFORMED	METHODS
Purity/Impurities	Pack/Cap Col. GC, FID, TCD, GD-MS
Water	KF Coulometric Titration
Halogen Ion	Ag ⁺ Qualitative / Visual / ISE
Non-Absorbable Gas	Packed Col. GC, TCD
High Boiling Residue	Evaporation / Gravimetric / Volumetric
Suspended Matter	Visual Observation / Gravimetric
Acidity	Aqueous Extration / Base Titration
Color	APHA Color Comparison
Free Halogen	Iodimetry / S ² O ³ – Titration
Viscosity	Cannon-Fenske
FT-IR	Transmission / ATR
Flash Point	Closed Cup

LAB USE ONLY

LAB NOTEBOOK #:

SAMPLE ID #:



Request for Refrigerant Analysis



- Complete this form and attach to the filled test cylinder.
- Follow cylinder filling instructions on reverse side.
- One form must be completed for each sample submitted.

Company: _____
 Address: _____

 Job Location: _____
 Phone: _____ Fax: _____
 Contact: _____
 Email Address: _____
 PO #: _____ UR Store #: _____

At Time Of Sampling:

• **System Running?** YES NO

• **Temperature of Sample (°F):** _____

System Serial #: _____
 Type of oil in system: _____
 Sample is: Liquid Cond. Vapor Vapor
 Sample ID: _____
 Submitted by: _____ Date: _____

REFRIGERANT	
<input type="checkbox"/> R-11	<input type="checkbox"/> R-404A
<input type="checkbox"/> R-12	<input type="checkbox"/> R-407A/B/C/D
<input type="checkbox"/> R-22	<input type="checkbox"/> R-408A
<input type="checkbox"/> R-113	<input type="checkbox"/> R-409A
<input type="checkbox"/> R-114	<input type="checkbox"/> R-410A/B
<input type="checkbox"/> R-123	<input type="checkbox"/> R-416A
<input type="checkbox"/> R-124	<input type="checkbox"/> R-417A
<input type="checkbox"/> R-125	<input type="checkbox"/> R-422A/B/C/D
<input type="checkbox"/> R-134a	<input type="checkbox"/> R-500
<input type="checkbox"/> R-142b	<input type="checkbox"/> R-502
<input type="checkbox"/> R-401A/B	<input type="checkbox"/> R-507
<input type="checkbox"/> R-402A/B	<input type="checkbox"/> R-509
<input type="checkbox"/> R-403B	<input type="checkbox"/> OTHER

SOURCE OF SAMPLE
<input type="checkbox"/> New factory filled cylinders
<input type="checkbox"/> Used-Refrigerant drum or cylinder
<input type="checkbox"/> Centrifugal refrigerant system with purge unit
<input type="checkbox"/> Centrifugal refrigerant system without purge unit
<input type="checkbox"/> Reciprocating refrigerant system
<input type="checkbox"/> Hermetic <input type="checkbox"/> Open
<input type="checkbox"/> Rotary System
<input type="checkbox"/> Other

APPLICATION
<input type="checkbox"/> Evaporator temperature:
<input type="checkbox"/> Condensing medium
<input type="checkbox"/> Evaporator type:
<input type="checkbox"/> DX:
<input type="checkbox"/> Flooded:
<input type="checkbox"/> Shell & Tube:
<input type="checkbox"/> System Size: HP Tons
<input type="checkbox"/> Refrigerant Charge (lbs.):

SAMPLE TAKEN FROM
<input type="checkbox"/> Vapor Phase at:
<input type="checkbox"/> Liquid Line
<input type="checkbox"/> Condenser
<input type="checkbox"/> Compressor – Suction
<input type="checkbox"/> Compressor – Discharge
<input type="checkbox"/> Receiver
<input type="checkbox"/> Recovery / Recycle Unit
<input type="checkbox"/> Recovery / Cylinder / Drum
<input type="checkbox"/> Other

REASON FOR ANALYSIS REQUEST
<input type="checkbox"/> Air / Water leak suspected
<input type="checkbox"/> Evidence of corrosion
<input type="checkbox"/> Oil sludged or darkened
<input type="checkbox"/> Excessive head pressure
<input type="checkbox"/> Suspect excess oil evaporator
<input type="checkbox"/> Compressor burn-out
<input type="checkbox"/> Desire condition of refrigerant
<input type="checkbox"/> Other

ANALYSIS DESIRED
<input type="checkbox"/> Moisture – ppm
<input type="checkbox"/> High boiling residue (oil) – %
<input type="checkbox"/> Acidity – ppm as HC1
<input type="checkbox"/> Identification – IR
<input type="checkbox"/> Purity – GC
<input type="checkbox"/> Particulates
<input type="checkbox"/> Chloride

COMMENTS OR SPECIAL REQUESTS

SHIP SAMPLE TO:

Sampling Procedures on reverse side.





Cylinder Sampling Procedures

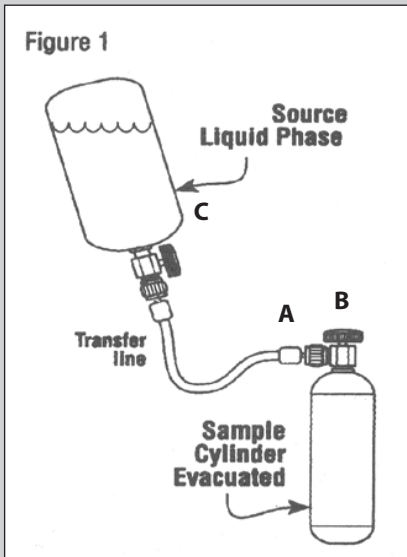

Liquid Phase

(Refer to Figure 1)

1. Use a heat gun, or otherwise dry the connection at the sample source, "C".
2. Connect a vacuum gauge to the sample cylinder or otherwise ensure that the sample cylinder is a full vacuum (-30"Hg). Tare weigh the cylinder to the nearest ounce.
3. Connect a clean, dry, flex transfer line to the refrigerant source at point "C". Dry the sample cylinder at point "A".
4. Carefully open valve "C" and purge a small amount of liquid-phase through the line. Then immediately connect the line to the sample cylinder at point "A".
5. Open valve "B". Then slowly open valve "C" as to fill the cylinder to about 85-90% volume capacity. Close valves "C" and "B".

Note: External cooling of the sample cylinder may be necessary to sample the refrigerant.

6. Disconnect the flex line at "A" and re-weigh the cylinder to ensure sufficient sample has been taken.
7. Soap bubble check the sample cylinder valve and valve connection to the cylinder for any leaks.

Vapor Phase

(Refer to Figure 2)

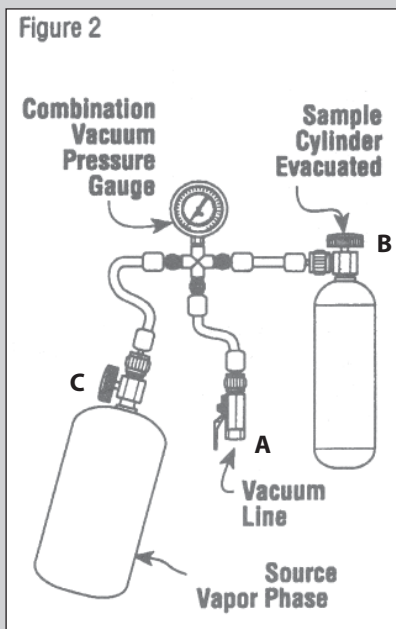

1. Connect as shown and then with valve "C" closed and valve "B" opened, slowly open valve "A" until the gauge reads -30 in. Hg.
2. Close valve "A".
3. Slowly open valve "C" as to bring the pressure to slightly above 1 atm. Close valve "C".
4. Open valve "A" until full vacuum is attained. Close valve "A".
5. Wait 5 minutes to ensure there are no leaks. Gauge should hold full vacuum.
6. Slowly open valve "C" and bring cylinder to either full head space pressure or to a **maximum** of 100 psig, whichever comes first.

Do not exceed 100 psig. Close valve "C" and "B".

7. Disconnect sample cylinder and soap bubble check for leaks.
8. Submit for NCG analysis.

CHECK LIST:

Did you remember to:

- Tightly close all valves?
- Weigh cylinder to make sure a sufficient sample was taken?
- Completely fill out the **Request for Refrigerant Analysis Form** (on reverse side)?
- Provide your FAX number and email address so we can return your test results?



Refrigeration Analysis Request Form on reverse side.

LAB USE ONLY
ID #:



Request for Oil Analysis

- Complete this form and attach to the filled test cylinder.
- Follow cylinder filling instructions on reverse side.
- One form must be completed for each sample submitted.

Company: _____
 Attn: _____
 Address: _____

 Job Location: _____
 Phone: _____ Fax: _____
 Email Address: _____
 PO #: _____ UR Store #: _____
 Sample ID: _____
 Date sample taken: _____

PLEASE CHECK TESTS REQUIRED	
<input type="checkbox"/> Identification of type of oil	
<input type="checkbox"/> Residual mineral oil in POE oil	
<input type="checkbox"/> Residual mineral oil in AB oil	
<input type="checkbox"/> Compressor-Discharge	<input type="checkbox"/> Acidity
<input type="checkbox"/> Appearance Unit	<input type="checkbox"/> Viscosity
<input type="checkbox"/> Moisture	<input type="checkbox"/> Wear Metals
<input type="checkbox"/> Other (explain)	

COMMENTS OR SPECIAL REQUESTS

COMPRESSOR INFORMATION			
Hermetic?	<input type="checkbox"/> YES	<input type="checkbox"/> NO	
	<input type="checkbox"/> Centrifugal	<input type="checkbox"/> Rotary	
	<input type="checkbox"/> Reciprocating	<input type="checkbox"/> Screw	
	<input type="checkbox"/> Other: (describe)		
*Compressor serial no:			
Oil mfr/brand or type/grade:			
Last date of oil change:			
Hours operating since last oil change:			
Sump Cap:	Gal:	Qt:	L:
Oil additive present:			
Compressor mfr/brand:			

SYSTEM INFORMATION	
Unit mfr/model:	
Unit serial no:	
Refrigerant:	
No. filters/driers	
Last date of filter/drier change:	
Retrofit in progress:	<input type="checkbox"/> YES <input type="checkbox"/> NO
If YES , please complete below:	
Original oil type:	
New oil type:	

*Required for historical data reporting

SHIP SAMPLE TO:

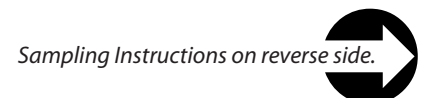



Oil Laboratory

This Kit Contains:

- ❖ (1) Sample bottle
- ❖ (1) Identification label
- ❖ (1) Sample

HOW TO USE THIS SERVICE:

1. Collecting Samples:

Oil should be taken from the unit immediately after shutdown, and/or while running at operating temperature so as to obtain a representative sample. The sample should be taken from the crankcase at the drain plug. Upon opening the plug, drain off a small amount of oil before taking the sample as to avoid contamination. Once drawn, allow the sample to de-gas before tightening the lid. Fill the container about 3/4 full.

NOTE: Synthetic oils are hygroscopic and must be sampled without excessive exposure to ambient air, i.e., attach the lid securely immediately following the degassing period.

2. Identification Labels:

Fill out a label completely for each compressor sampled. Print your name, job, compressor serial number and sampling date on the label.

3. Sample Request Form:

Be sure to include all of the information requested (hours since oil change, hours since new/overhauled, or last major repair, oil type, etc.) Include all unit/component information.

4. Sending the Sample:

Be sure the identification label is attached to the sample bottle. Be sure the sample bottle lid is securely tightened. Fold the sample request form and place it around the other bottle inside the pre-addressed mailing box. Always use first class postage, air freight or overnight (FedEx, etc.) for quick service.

RETURN SAMPLE TO:



National Refrigerants, Inc.

Analytical Laboratory
661 Kenyon Avenue
Rosenhayn, NJ 08352



Oil Analysis Request Form on reverse side.



Recovery Cylinder Hydrostatic Test & Refurbish Program

Refrigerant Recovery Cylinders require a Department of Transportation (DOT) hydrostatic recertification every 5 years. This requires the cylinder to have a visual, internal and external examination and a test by interior hydrostatic pressure in a water jacket for determination of the expansion of the cylinders. NRI is a DOT approved hydrostatic test facility and offers other cylinder refurbishing services. Below are details of NRI's cylinder refurbishing program offered to owners of recovery cylinders.

Please call for a quotation for any service not listed.

HYDROSTATIC TEST

Includes:

- ❖ hydrostatic test
- ❖ internal drying
- ❖ test date engraved on collar/body of cylinder

HYDROSTATIC TEST & REFURBISH

Includes:

- ❖ hydrostatic test
- ❖ removal of old paint
- ❖ application of grey/yellow paint
- ❖ dip tube replacement
- ❖ internal drying
- ❖ dual port valve replacement
- ❖ test date engraved on collar/body of cylinder



The above services are generally available for all cylinders listed below

- 30 lb. & 50 lb. recovery cylinders (DOT 4BA, 4BW)
- 125 lb. recovery cylinders (DOT 4BA, 4BW)
- 240 lb. recovery cylinders (DOT 4BA, 4BW)
- 1000 lb. recovery cylinders (DOT 4BA, 4BW)
- 2000 lb. recovery cylinders (DOT 106A, 110A)

Additional work may be necessary for DOT Certification. Customer will be notified before work begins if additional costs will be incurred. Please call for pricing.



Refrigerant Recovery Containers



EZ ONE-SHOT™ disposable cylinder is rated to 400 psi and is guaranteed to be rated to recover R-410A.

PRESSURIZED RECOVERY CYLINDERS	SIZE
	30 lbs.
	40 lbs.
	50 lbs.
	50 lbs. HP **
	50 lbs. w/float
	125 lbs.
	1,000 lbs.
	2,000 lbs.

**50 lb. HP deposit cylinder is also rated to 400 psi and can be used to recover R-410A

RECOVERY DRUMS FOR :	Size
R-11	100 lbs. (10 gal)
R-113	200 lbs. (20 gal)
R-123	650 lbs. (55 gal)

VERY HIGH PRESSURE RECOVERY CYLINDERS	Size
	9 lbs.
	23 lbs.
	80 lbs.

Guidelines:

- ❖ A service fee is charged when cylinders are taken for use by customer.
- ❖ Cylinder deposits are credited back to customer upon return of cylinder.
- ❖ Drums for low pressure refrigerant recovery are rated as single trip containers, therefore they are purchased outright.
- ❖ National uses its own on-site DOT approved hydrostatic testing equipment. All cylinders are shipped under a partial vacuum. Cylinders should be fully evacuated with a vacuum pump prior to use. For the user's protection, a plastic shrink wrap covers the valve.
- ❖ Please read Filling Procedures and Safety Recommendations to ensure proper transfer of recovered refrigerant in to containers.
- ❖ National reserves the right to charge a cylinder cleaning fee for cylinders used as receivers or returned less than 50% full.



Instructions for Participating in NRI's Refrigerant Reclamation Program

Instructions for Participating in NRI's Refrigerant Reclamation Program

1. Obtain a Recovered Refrigerant tag/label and container(s) from either NRI or an authorized distributor.
2. Fill out a Recovered Refrigerant Tag for each recovery cylinder and a Recovered Refrigerant Label for each drum. Bill of Lading number must be written on each label/tag and the appropriate panel on the EZ ONE-SHOT™ disposable 30 lb. recovery cylinder.
3. Fill the containers according to NRI Filling Instructions.
4. All Material must meet NRI Recovered Refrigerant Acceptance Specifications. Please see Terms and Conditions for additional information.
5. Ship your properly filled and tagged containers to:
National Refrigerants, Inc.
661 Kenyon Avenue
Rosenhayn, NJ 08352
 or an authorized NRI Distributor

Purity	98% minimum for all HCFCs & HFCs 99.5% for all CFCs
Component Ratios/Composition	must be within AHRI 700 Specifications for allowable composition (weight). Composition must be within ASHRAE classification for toxicity and flammability.
Oil	not to exceed 20% by weight in R-11, R-113 & R-123; not to exceed 10% by weight all others
Water	not to exceed saturation point of refrigerant
Acid	pH must be greater than 2.0 and less than 12.0
Dyes	not to exceed 1% by weight
Hydrocarbons	not to exceed 0.5% by weight

Recovered Refrigerant Acceptance Specifications

1. Only fluorocarbon refrigerants from refrigeration and air conditioning systems are accepted. Halons will not be accepted. Fluorocarbons from other applications, such as solvents or cleaning agents, are NOT acceptable.
2. Non-Fluorocarbon refrigerants, such as ammonia, methylene chloride, propane, ethane, sulfur dioxide, etc. are NOT acceptable. Also, fluorocarbon refrigerants contaminated with hydrocarbons in excess of 0.5% by weight (total hydrocarbons) will not be accepted.
3. Only one type of refrigerant per container is acceptable. Refrigerant must be shipped in DOT-approved recovery containers. Refer to AHRI Guideline K. R-11, R-113 and R-123 must be shipped in drums to avoid additional handling fees.
4. Containers must not exceed Maximum Allowable Gross Weight as specified in NRI's Cylinder Weight Chart. Overfilled containers will be subject to a handling fee.
5. Refrigerant Contaminants are acceptable with the following limits (**chart above**):

Safety Recommendations

1. Only fill cylinders that are currently DOT approved for fluorocarbon refrigerants. Always inspect the cylinder for proper pressure rating and latest hydrostatic test date. Thoroughly check each cylinder and drum for dents, gouges, bulges, cuts or other imperfections, which may render it unsafe to hold refrigerant for storage or transportation.
2. It is highly recommended to read the Air Conditioning, Heating & Refrigeration Institute "Guideline K-Guideline for Containers for Recovered Fluorocarbon Refrigerants".
3. Be sure all connections are made tight before transferring refrigerant into containers. Be sure all closures are made tight on the container immediately after filling. Be sure to replace valve outlet caps on cylinders.
4. Always use a scale when filling any cylinder. DO NOT OVERFILL.
5. **Caution:** Liquid refrigerant can cause frostbite if skin contact occurs. Be aware that the refrigerant/oil being removed from a system may contain contaminants, which may be harmful to breathe. Avoid contact with skin. Always provide fresh air when working in enclosed areas. Avoid breathing vapors. Always wear safety glasses and gloves (cold resistant for pressurized refrigerants and rubber-type for R11, R113 or R123). Avoid contact with clothing.



Filling Procedure for Recovered Refrigerant

1. Visually inspect the container to be filled. Use vacuum pump to pull cylinder into full vacuum. Strictly follow all DOT requirements for inspection of refrigerant containers. For all cylinders, leak test with a vacuum gauge. Do not fill a leaking cylinder. NRI is not responsible for refrigerant recovered into a leaking cylinder.
2. Place the container on a scale. Note empty weight of container to determine the maximum gross weight. Add the corresponding maximum refrigerant weight to the tare weight to get the maximum allowable gross shipping weight. (See Guidelines for Maximum Shipping Weight.)
3. Connect transfer hoses to the container. Make certain hoses are leak free. If possible, change hoses when recovering different types of refrigerant to avoid contamination by unintentionally mixing refrigerants.
4. Open container outlets and begin the transfer process following manufacturer's instructions for the recovery unit. DO NOT LEAVE THE CONTAINER UNATTENDED. Watch the scale closely. DO NOT OVERFILL. Do not exceed the gross weight limit. Do not fill more than 80% by volume. It is illegal to transport an overfilled cylinder.
5. When the scale reaches the gross weight limit-stop the transfer process. Tightly close all valves and other outlets. Disconnect the transfer hose. AVOID CONTACT WITH LIQUID REFRIGERANT/OIL MIXTURES. Immediately replace all valve outlet caps and other container closures.
6. NRI does not recommend using a recovered refrigerant cylinder as a temporary storage container. NRI recommends the use of the EZ ONE-SHOT disposable recovery cylinder when the recovered refrigerant will be returned to a system without processing.
7. Weigh the container. Always use a scale. DO NOT OVERFILL. Write the weight on all appropriate forms and on the container tag or label.
8. Completely fill out the container tag or label. Be sure the tag or label indicates the correct refrigerant in the container. It is illegal to transport a container without identifying the contents (including empty cylinders).
9. There will be a cylinder cleaning charge for cylinders returned less than 50% full. Check off the "For Cleaning Only" box on the hang tag. R11, R113 & R123 must be shipped in drums to avoid additional handling fees.
10. Ship your properly filled and tagged containers to an authorized NRI distributor.

Terms and Conditions

1. All used refrigerants must meet "Recovered Refrigerant Acceptance Specifications". NRI will accept title to shipment only after it has been verified through analysis, in NRI's laboratory, that these standards have been met. Off specification material may, at NRI's option, be returned to the customer freight-collect or disposed of in a manner agreeable to both NRI and the customer at customer's sole expense.
2. Refrigerant must be shipped in DOT approved containers. Any shipments not meeting this specification will be refused. Containers must be properly skidded and banded for shipment. Drums must not have any rust, dents, bulges or leaks. Open-top drums are not acceptable. NRI will not be liable for any claims, damages, lawsuits, judgments or liabilities caused by or resulting from the fault or negligence of the shipper.
3. NRI reserves the right to charge cylinder refurbishing fees for any NRI owned cylinder that is returned damaged or defaced. A cleaning fee may be charged for each container that is returned with less than 50% of the maximum fill weight of recovered refrigerant. Handling fees may be charged for recovered refrigerant that requires special handling by NRI.

Recovered Refrigerant Handling Fees

1. **Cylinder Handling Fee:** Customers returning recovery cylinders containing recovered refrigerant will be charged a handling fee according to the current price schedules.
2. **Free standing water:** Water exceeding saturation point of refrigerant; requires special processing to separate the water from the refrigerant; waste must be sent to waste water processing facility for purification.
3. **Excessive oil content:** Refrigerant oil (mineral or synthetic) that exceeds ARI Acceptance Specification (10% for high pressure; 30% for low pressure): fee will be charged for each pound of oil exceeding Acceptance Specifications.
4. **High acid content:** Acid present in the refrigerant at such a concentration that the pH level of the material is between 2.0 and 5.0 (a pH level below 2.0 would classify the material as hazardous waste according the 40CFR); such material must be handled as a priority in order to effectively neutralize the acid in the material
5. **Over-filled container:** Cylinders and drums exceeding the maximum Gross Weight as specified in NRI's Cylinder Weight Chart that require special handling; these containers must be handled as a priority as soon as they are received to prevent injury to NRI or other persons and to prevent the release of the material in the container to the atmosphere.



EZ ONE-SHOT™ Recovery Cylinder

EZ ONE-SHOT™ cylinders use DOT-39 disposable cylinder technology to provide an inexpensive, lightweight cylinder for use in one-time fill recovery situations

Applications for the EZ ONE-SHOT™

- Temporary storage receiver (where policy demands clean cylinder for each job)
- Single recovery job where gas will need to be returned or stored
 - One 20 to 30 lb. recovery job
 - Several smaller jobs at the same site
 - Burned gas: avoid contamination of your everyday recovery cylinder
 - Infrequent jobs or products not regularly recovered: won't tie up a standard cylinder
 - Dedicated shop machines
 - Download everyday cylinder to return refrigerant

Back Flow Prevention Valves

EZ ONE-SHOT™ cylinders are equipped with back flow prevention devices inside the valves. THE CYLINDERS ARE SHIPPED WITH THE VALVES OPEN.

- Cylinders must be evacuated before use, but after hoses are connected.
- Once the cylinder valve is closed for the first time, the back flow prevention device seats in the valve. No more refrigerant can be added to the cylinder through that valve.
- Be sure that all recovery operations are complete before closing both valves to the cylinder.
- Refrigerant can be removed from the cylinder just like any other supply cylinder.



One-Time Fill

One-time fill means that once refrigerant has been put into the cylinder and then removed, the cylinder may no longer be used for further recovery operations. It must be scrapped or disposed of properly. Recovering refrigerant with an EZ ONE-SHOT™ recovery cylinder is considered the first filling operation. Recovery from several units, one after the other, until the cylinder is full represents one filling operation (for example, a dedicated shop machine).

EZ ONE-SHOT™ recovery cylinders are subject to the same regulations as the “disposable” refrigerant cylinders that refrigerant is supplied in. Federal law forbids transportation if REFILLED. Federal law also requires that cylinders transported in the box provided. Penalty up to \$500,000 fine and 5 years imprisonment (49 U.S.C. 5124).



Procedures for Using EZ ONE-SHOT™ Recovery Cylinder

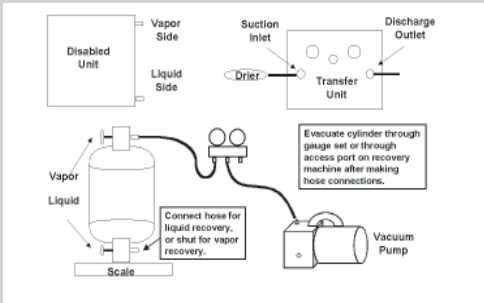

Figure 1: Evacuate Cylinder

- If performing liquid recovery, arrange hoses as indicated in **Fig. 2**.
- If performing vapor recovery, arrange hoses as indicated in **Fig. 3**.
- Evacuate cylinder with vacuum pump through a gauge set placed in the vapor line, or through an access port on the recovery machine, if available.

DO NOT CLOSE CYLINDER VALVES.

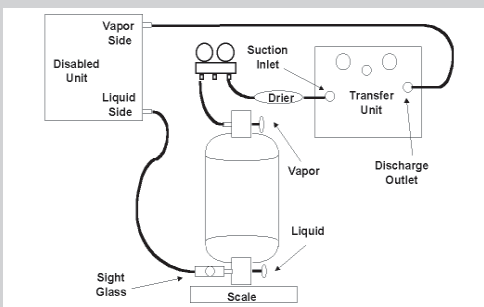

Figure 2: Liquid Recovery

Recovery machine draws vapor from the cylinder and uses this vapor to push liquid out of the system back into the cylinder.

- Vapor valve is at top of cylinder
 - Liquid valve is at bottom
- If also performing vapor recovery:*
- Close liquid valve when the sight glass clears, BEFORE turning off the recovery machine.
 - Use gauge set on vapor line to transfer hoses on recovery machine to configuration in Fig. 3.

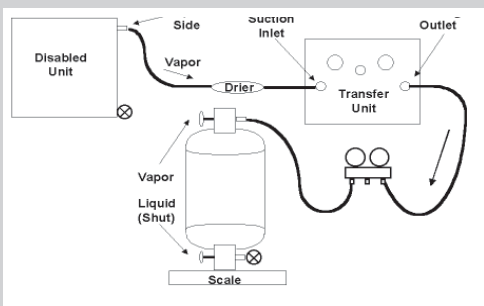

Figure 3: Vapor Recovery

Vapor recovery operations are performed normally, with access to the cylinder only through the vapor valve. Close bottom valve on cylinder. Complete all recovery operations, including purging procedures for the recovery unit, before closing the vapor valve.

Once cylinder valves are closed no more refrigerant can be added to the cylinder.

Maximum Shipping Weight of Recovered Refrigerant in EZ ONE-SHOT™ Recovery Cylinder

Refrigerant	Max Ship Wt./Lbs.
R-12	42
R-22	39
R-114	36
R-134a	40
R-401A/B	39
R-402A/B	38
R-404A	36

Refrigerant	Max Ship Wt./Lbs.
R-407A/C	38
R-408A	36
R-409A	40
R-410A	36
R-422B	38
R-502	40
R-507	36

The information contained herein is based on technical data which we believe to be reliable and is intended for use by persons having technical skill, at their own discretion and risk. National Refrigerants, Inc. makes no warranties, either expressed or implied, regarding the merchantability or fitness of this product and assumes no liability for consequential damages resulting from the use or misuse of this product.



Recovered Refrigerant BANKING GUIDELINES

INITIAL DEPOSIT

An initial deposit of 500 lbs. of refrigerant is required to open an account. This can be comprised of different types of refrigerant. Refrigerant must meet NRI's **Recovered Refrigerant Acceptance Specifications**.

FUTURE DEPOSIT

After the initial deposit of a minimum of 500 lbs., subsequent deposits are accepted for a minimum of 500 lbs. per deposit.

- ❖ Deposits of low pressure refrigerants are accepted in 100 lb. drums and larger.
- ❖ Deposits of high pressure refrigerants are accepted in 125 lb. cylinders and larger.
- ❖ CYLINDERS LESS THAN 125 LBS. ARE NOT ELIGIBLE FOR BANKING.

MINIMUM BALANCE

If during the course of any month, customer account balance falls below a total of 1,000 lbs., NRI may purchase the balance of refrigerants as outlined below.

CHARGES

NRI will invoice you for the processing of the total weight of verified refrigerant than can be reclaimed to AHRI 700 Specifications plus any contaminant/disposal fees. A nominal charge for disposable 30 lb. and 50 lb. cylinders is charged at time of withdrawal. Storage fees on balance will be billed monthly. Please call for current pricing.

HANDLING FEES/DISPOSAL CHARGES

- Oil Disposal greater than 20% (low pressure)
- Oil Disposal greater than 10% (high pressure)
- Free Standing Water
- High Acid Content
- Mixed Refrigerant
- Over-filled container

Disposal charges for contaminants above accepted levels will be determined on a case-by-case basis.

STORAGE

The net reclaimed refrigerant is placed in bulk storage. A storage fee is billed on a monthly basis.

WITHDRAWAL

A faxed or written authorization is required for withdrawal of refrigerant from the bank. Upon receipt of the withdrawal authorization at NRI, product will be made available as soon as reasonably possible for pick up or shipment. Customer will be responsible for freight on all shipments.

REPORTS

A banking report and invoice will be issued to the customer monthly.

NRI PURCHASE

If, at a later date, the customer does not require the banked refrigerant, NRI may purchase same at a mutually agreed upon price.

All rates, terms and prices are subject to change. Prices do not include sales tax, if any. NRI reserves the right to alter its program upon 30 days notice.

REFRIGERANTS	
R-11	R-404A
R-12	R-407A
R-113	R-407C
R-114	R-408A
R-123	R-409A
R-134a	R-410A
R-22	R-500
R-401A	R-502
R-401B	R-507
Cylinder Charge for W/D	
30 lbs	Call for price
50 lbs.	
Drum Charge for W/D	
100	Market Price
200	Market Price

* Cylinder charge subject to change without notice





Guidelines for Maximum Shipping Weights for Recovered Refrigerant Containers

Cylinder Size	30 lb.	EZ One Shot 30 lb.	40 lb.	50 lb.*	125 lb.	1/2 ton	ton
Water Capacity	26.2 lbs.	29.7 lbs.	38.1 lbs.	47.7 lbs.	123 lbs.	1,000 lbs.	1,600 lbs.

*includes 50F and 50HP

MAXIMUM REFRIGERANT WEIGHT ALLOWED

R-12 *	27	31	40	50	129	1049	1678
R-22 *	25	28	36	45	117	953	1524
R-500 *	24	27	35	44	112	913	1461
R-502 *	25	29	37	46	119	971	1554
R-507A **	22	25	32	40	103	838	1341
R-114 *	30	35	44	56	143	1164	1862
R-124 *	28	32	41	52	133	1084	1734
R-134a *	25	29	37	46	119	966	1545
R-401A *	25	28	36	45	117	952	1523
R-401B *	25	28	36	45	117	951	1522
R-402A ***	24	27	35	44	113	917	1467
R-402B **	24	27	35	44	113	920	1472
R-403B **	23	26	34	42	109	888	1421
R-404A **	22	25	32	40	103	835	1336
R-406A *	23	26	34	42	108	882	1411
R-407A **	24	27	35	44	113	916	1466
R-407C **	24	27	35	43	112	910	1456
R-407D *	24	28	35	44	114	929	1487
R-407F **	23	27	34	43	110	894	1430
R-408A **	22	25	32	40	104	848	1356
R-409A *	25	29	37	46	119	971	1554
R-410A ****	22	25	32	40	104	847	1355
R-414B *	25	29	37	46	119	971	1554
R-416A *	26	29	37	47	121	983	1572
R-417A *	24	27	35	44	113	921	1474
R-417C *	25	28	36	45	116	944	1510
R-422A **	24	27	35	43	111	908	1454
R-422B *	24	27	35	44	113	922	1476
R-422C **	24	27	35	44	113	915	1464
R-422D **	24	27	35	44	113	915	1464
R-422E **	24	27	35	44	114	926	1481
R-427A **	24	27	34	43	111	903	1445
R-438A **	24	27	35	44	113	917	1468

Minimum cylinder service pressure required (psig) for each different refrigerant is indicated above by *
 260 psig = * 300 psig = ** 350 psig = *** 400 psig = ****

Low Pressure Containers	Drum Size	Max Allowable Refrigerant Weight	Average Drum Tare Weight	Max Gross Shipping Weight
R-11, R-113, R-123	100 lbs.	90 lbs.	10 lbs.	100 lbs.
	200 lbs.	180 lbs.	20 lbs.	200 lbs.
	650 lbs.	585 lbs.	65 lbs.	650 lbs.

Very High Pressure Cylinders	RC9 avg tw 20		RC23 avg tw 30		RC80 avg tw 140	
	Recovered Refrigerant Weight + Tare Weight of Cylinder = Maximum Gross Shipping Weight					
	Ref Wt	Ship Wt	Ref Wt	Ship Wt	Ref Wt	Ship Wt
R-13	14	34	19	49	74	211
R-23	11	31	15	45	58	198
R-503	12	32	16	46	64	206
R-508B	12	32	17	47	65	205
R-13B1	17	37	12	52	89	229



IMPORTANT: The tare weights listed in this guideline are only average weights. In order to determine actual gross shipping weight, the tare weight of each individual cylinder must be used.

Always use a scale when filling any cylinder. DO NOT OVERFILL



IV

ADDITIONAL TECHNICAL LITERATURE

- 114 Glossary of Terms
- 118  Lubricant Cross Reference Guide
- 122  Lubricants
- 126  Propylene Glycol





Alkylbenzene Oil: A synthetic refrigeration oil similar to mineral oil; it offers better low temperature mixing with HCFCs.

Appliance: Any device that contains and uses a Class I or Class II substance as a refrigerant and is used for household or commercial purposes, including any air conditioner, refrigerator, chiller or freezer.

Azeotrope: A mixture of two or more refrigerants that acts as a single fluid. The components of azeotropic mixtures will not separate under normal operating conditions.

Blend: A mixture of two or more refrigerant components.

Brazed: Joined by fusion using very high heat; equivalent of hard soldering.

Capacity: The measure of heat energy removed by a system per hour. The capacity is very dependent on running and ambient conditions and it is typically quoted for a compressor or system at some standard rating condition.

Centrifugal Air Conditioning: Compressor technology used in larger air conditioning chillers, based on a rotating impeller to “spin” refrigerant to a higher pressure/temperature.

CFC: Chloro-Fluoro-Carbon; a refrigerant comprised of carbon atoms connected to only chlorine and fluorine atoms. The common CFCs are R-11, R-12, R-13, R-113, R-114 and R-115.

Class I: Chemicals listed in the Clean Air Act having an ozone depletion potential of 0.2 or higher. These include CFCs, halons, carbon tetrachloride, methyl chloroform, and bromine compounds.

Class II: Chemicals listed in the Clean Air Act having an ozone depletion potential of less than 0.2. All of the HCFCs are considered Class II.

Commercial Refrigeration: The refrigeration appliances used in the retail food and cold storage warehouse sectors. Retail food includes the refrigeration equipment found in supermarkets, convenience stores, restaurants and other food service establishments. Cold storage includes the equipment used to store meat, produce, dairy, and other perishable goods, usually in very large facilities.

Direct Expansion: A system design that meters refrigerant into the evaporator with the intention that it will all boil to vapor by the time it reaches the end. Orifice plates, capillary tubes, automatic expansion valves, and TXVs are all expansion devices that provide for direct expansion of refrigerant in the evaporator.

Disposal: The process leading to and including (1) the discharge, deposit, dumping or placing of any discarded appliance into or on any land or water, (2) the disassembly of any appliance for discharge, deposit, dumping or placing of its discarded component parts into or on any land or water, or (3) the disassembly of any appliance for reuse of its component parts.

Efficiency: Ratio of the work output to the energy input.

Elastomer: Material which can be stretched or squeezed and, immediately on release of the stress, returns to its approximate dimensions.



Equilibrium: Liquid and vapor phases of refrigerant existing in contact with each other at a saturated pressure/temperature condition. For blends, the composition of the vapor will contain more of the higher pressure components.

Flooded Evaporator Systems: A system design that allows the refrigerant to boil in a pool in the evaporator, which cools the water, glycol or product that is circulating through tubing or panels in the boiling pool, and only the vapor that is boiled goes back to the compressor.

Fractionation: Change in composition of a blend by preferential evaporation of the more volatile components(s) or condensation of the less volatile component(s).

Global Warming or “Greenhouse Effect”: Occurs when carbon dioxide and other gases, including refrigerants, build up in the atmosphere. These gases allow sunlight to pass through to the earth; however, the gases trap heat energy from the earth and the planet’s average temperature is raised.

Global Warming potential or GWP: A relative measure of how effective a chemical is at retaining heat in the atmosphere. The value shows the effect of an equivalent number of kilograms of CO₂ on global warming.

HC: Hydrocarbon refrigerants, used primarily as additives in blends. They will help promote circulation of mineral oil when the blend components will not accomplish this alone.

HCFC: Hydro-Chloro-Fluoro-Carbon; a refrigerant comprised of carbon atoms connected to chlorine, fluorine, and hydrogen atoms. The common HCFCs are R-22, R-123, R-124, R-142b

HFC: Hydro-Fluoro-Carbon; a refrigerant comprised of carbon atoms connected to fluorine and hydrogen only. The common HFCs are R-134a, R-125, R-143a, R-152a, R-32 and R-23

High Ambient Air Conditioning: An air conditioning application where the surrounding air temperatures are higher than normal, which requires a slightly lower refrigerant pressure and very large condensing surface in order to work correctly. (Example: crane control room in a steel mill.)

High Pressure Appliance: An appliance that uses refrigerant with a boiling point between -50°C (-55°F) and 10°C (40°F) at atmospheric pressure. This definition includes, but is not limited to, appliances that use R-12, R-22, R-114, R-500 or R-502.

High Temperature Refrigeration: Refrigeration applications where the evaporator temperature normally runs higher than 30°F.

Household Appliance: The standard refrigerator/freezer found in most kitchens, as well as small freezer appliances sold to homeowners.

Hygroscopic: A tendency for refrigeration oils to absorb moisture from the atmosphere.

Industrial Process Refrigeration: Complex, customized appliances used in the chemical, pharmaceutical, petrochemical and manufacturing industries. This sector also includes industrial ice machines and ice rinks.



Low-Loss Fitting: Any device that is intended to establish a connection between hoses, appliances, or recovery or recycling machines, which is designed to close automatically or will be closed manually when disconnected, thereby minimizing the release of refrigerant from hoses, appliances, and recovery/recycling machines.

Low-Pressure Appliance: An appliance that uses a refrigerant with a boiling point above 10°C (40°F) at atmospheric pressure. This definition includes, but is not limited to, equipment utilizing R-11, R-113, and R-123.

Low Temperature Refrigeration: Refrigeration applications that normally run evaporator temperatures between -40°F and 0°F.

Medium Temperature Refrigeration: Refrigeration applications that normally run evaporator temperatures between 0°F and 40°F.

Mineral Oil: Traditional refrigeration oil, refined from petroleum products. Generally not compatible with new HFC refrigerants.

Miscibility: Ability of a gas or liquid to dissolve uniformly (mix) in another gas or liquid.

Motor Vehicle Air Conditioner (MVAC): Any appliance that is contained in a motor vehicle and is used to cool the driver's or passenger's compartment. MVAC is regulated under the Clean Air Act Section 609.

MVAC-Like Appliance: Air conditioning equipment used to cool the driver's or passenger's compartment of a non-road vehicle. The system is similar in construction to MVAC equipment; however R-22 equipment is excluded from this definition.

Oil Flushing: The process of changing from one type of lubricant (typically mineral oil or alkylbenzene) to another type (typically POE), which involves the removal of an oil charge and replacement with the new oil type. Successive oil changes will quickly lower the concentration of the original oil type.

Opening an Appliance: Any service, maintenance, or repair on an appliance that could be reasonably expected to release refrigerant from the appliance to the atmosphere unless the refrigerant was previously recovered from the appliance.

Ozone Depletion: The interruption by free chlorine radicals of the normal ozone creation/breakdown process which occurs in the upper atmosphere. The free chlorine causes ozone molecules to come apart, then ties up the free oxygen used to make for ozone. The result is a net decrease in the ozone concentration.

Poly-Alkylene-Glycol (PAG) Oil: A general term that applies to a family of synthetic oils based on polyalkylene glycols chemistry. PAGs are used primarily with HFC refrigerants in the automotive air conditioning industry.

Process Stub: A length of tubing that provides access to the refrigerant inside an appliance and that can be resealed at the conclusion of repair or service.

Propylene Glycol: A type of heat transfer fluid used in secondary loop chillers. Because of the low toxicity of propylene glycol, this product is often used when failure of the cooling piping might allow contact of the glycol with food products.



Pump-Down (Out): The withdrawal of all refrigerant from the low side of a system by pumping it into either the condenser or the liquid receiver.

Reclaim: To reprocess refrigerant to at least the purity specified in the AHRI Standard 700, Specifications for Fluorocarbon Refrigerants, and to verify this purity using the specified analytical methods.

Recovery: To remove refrigerant from a system, regardless of condition, and store it in an external container without necessarily testing or processing the refrigerant in any way.

Recovery Efficiency: The percentage of refrigerant recovered compared to the total amount in the appliance.

Recycle: To extract refrigerant from an appliance to attempt to clean water, oil, acidity and particulates from it. These procedures may not necessarily return the refrigerant to AHRI 700 purity. The refrigerant may be returned to the same system after recycling.

Repair: Fix what is wrong with a broken system without changing the type of refrigerant.

Replace: Install a new piece of equipment in the same application instead of repair or retrofit.

Retrofit: The replacement of the original refrigerant in a system with a different refrigerant, which may involve changing valves, oil, other components, or adjusting controls in some manner.

Self-Contained Recovery Equipment: Recovery equipment that is capable of removing refrigerant from an appliance without the assistance of components within the appliance.

Small Appliances: Any self-contained, hermetic appliance that contains 5 pounds or less of refrigerant.

System-Dependent Recovery Equipment: Recovery equipment that requires the assistance of components contained in an appliance to remove the refrigerant.

Temperature Glide: the change in temperature from when a blend first starts boiling in an evaporator to when it reaches saturated vapor at the end of the evaporator.

TXV (or TEV): Thermal Expansion Valve, which is used to meter the flow of refrigerant from the liquid line into the evaporator and provide the correct pressure drop.

Very Low Temperature or Ultra Low Temperature Refrigeration: Refrigeration applications that normally run evaporator temperatures below -60°F . These applications will often use a cascade or 2 stage refrigeration system.

Weight Percent: The relative amount of each component in a refrigerant blend on a mass basis (the pounds of each component relative to the total pounds in the blend).

Zeotrope: A blend that behaves normally as a mixture of refrigerants. The properties are a combination of the individual component properties, and the vapor composition is different from the liquid, which promotes fractionation and temperature glide effects. (see Section 2)



OEM PART #	Lubricant Type	Viscosity	
Bitzer B100	Mineral Oil	500 SUS / 100 ISO	NL 500
Bitzer 5.2	Alkylbenzene	150 SUS / 32 ISO	NL AKB 150
Bitzer BSE 32	Polyolester	32 ISO / 150 SUS	NL PE 32
Bitzer BSE 55	Polyolester	68 ISO / 300 SUS	NL PE 68
Bitzer BSE 170	Polyolester	170 ISO / 800 SUS	Solest 170
Bitzer BSE 220	Polyolester	220 ISO / 1000 SUS	Solest 220
Bitzer BSE 320SH	Polyolester	320 ISO / 1500 SUS	CP 4214-320
Bitzer BSE 150SH	Polyolester	150 ISO / 750 SUS	CP 4214-150
BVA 3	Mineral Oil	150 SUS / 32 ISO	NL 150
BVA 4	Mineral Oil	300 SUS / 68 ISO	NL 300
BVA 5	Mineral Oil	500 SUS / 100 ISO	NL 500
BVA Alkyl 150	Alkylbenzene	150 SUS / 32 ISO	NL AKB 150
BVA Alkyl 200ca	Alkylbenzene	200 SUS / 46 ISO	NL AKB 200R
BVA Alkyl 300	Alkylbenzene	300 SUS / 68 ISO	NL AKB 300
BVA RPOE LT32	Polyolester	32 ISO / 150 SUS	Solest LT32
BVA RPOE 32MA	Polyolester	32 ISO / 150 SUS	NL PE 32
BVA RPOE 68	Polyolester	68 ISO / 300 SUS	NL PE 68
BVA RPOE 120	Polyolester	120 ISO / 600 SUS	Solest 120
BVA RPOE 100	Polyolester	100 ISO / 500 SUS	Solest 100
BVA RPOE 170	Polyolester	170 ISO / 800 SUS	Solest 170
BVA RPOE 220	Polyolester	220 ISO / 1000 SUS	Solest 220
BVA Alkyl 100E	Alkylbenzene	500 SUS / 100 ISO	NL AKB 500E
Calumet RO-15	Mineral Oil	150 SUS / 32 ISO	NL 150
Calumet RO-30	Mineral Oil	300 SUS / 68 ISO	NL 300
Carrier PP45EB304	Mineral Oil	150 SUS / 32 ISO	NL 150
Carrier PP23BB005	Mineral Oil	300 SUS / 68 ISO	NL 300
Carrier PP23BB006	Mineral Oil	300 SUS / 68 ISO	NL 300
Carrier PP23BZ-105	Alkylbenzene	300 SUS / 68 ISO	NL AKB 300
Carrier PP23BZ-102	Polyolester	32 ISO / 150 SUS	NL PE 32
Carrier PP23BZ-106	Polyolester	32 ISO / 150 SUS	NL PE 32
Carrier PP23BZ-103	Polyolester	68 ISO / 300 SUS	NL PE 68
Carrier PP23BZ-107	Polyolester	68 ISO / 300 SUS	NL PE 68
Carrier PP23BZ-104	Polyolester	220 ISO / 1000 SUS	Emkarate RL 220H+
Carrier Spec: PP16-0	Mineral Oil	150 SUS / 32 ISO	NL 150
Carrier Spec: PP31-2	Mineral Oil	150 SUS / 32 ISO	NL 150
Carrier Spec: PP33-2	Mineral Oil	150 SUS / 32 ISO	NL 150
Carrier Spec: PP16-2	Mineral Oil	300 SUS / 68 ISO	NL 300
Carrier Spec: PP36-1	Mineral Oil	300 SUS / 68 ISO	NL 300
Carrier Spec: PP49-5	Mineral Oil	300 SUS / 68 ISO	NL 300
Carrier Spec: PP47-8	Alkylbenzene	150 SUS / 32 ISO	NL AKB 150
Carrier Spec: PP49-8	Alkylbenzene	300 SUS / 68 ISO	NL AKB 300
Carrier Spec: PP47-30	Polyolester	32 ISO / 150 SUS	NL PE 32



OEM PART #	Lubricant Type	Viscosity	
Carrier Spec: PP47-31	Polyolester	68 ISO / 300 SUS	NL PE 68
Carrier Spec: PP47-32	Polyolester	220 ISO / 1000 SUS	Emkarate RL 220H+
Carrier Spec: PP47-33	Polyolester	100 ISO / 500 SUS	Solest 100
Castrol SW32	Polyolester	32 ISO / 150 SUS	NL PE 32
Castrol SW68	Polyolester	68 ISO / 300 SUS	NL PE 68
Castrol SW220	Polyolester	220 ISO / 1000 SUS	Solest 220
Chevron (Texaco) Capella WF 32	Mineral Oil	150 SUS / 32 ISO	NL WF 32
Chevron (Texaco) Capella WF 68	Mineral Oil	300 SUS / 68 ISO	NL WF 68
Copeland Ultra 32-3MAF	Polyolester	32 ISO / 150 SUS	NL PE 32
Copeland Ultra 22CC	Polyolester	22 ISO / 100 SUS	NL PE 32
Copeland Ultra 32CC	Polyolester	32 ISO / 150 SUS	NL PE 32
Copeland 998-E170-xx	Polyolester	170 ISO / 800 SUS	CP 4214-150
Copeland 998-E320-xx	Polyolester	320 ISO / 1500 SUS	CP 4214-320
CPI Solest LT32	Polyolester	32 ISO / 150 SUS	Solest LT32
CPI Solest 46	Polyolester	46 ISO / 200 SUS	Solest 46
CPI Solest 68	Polyolester	68 ISO / 300 SUS	Solest 68
CPI Solest 100	Polyolester	100 ISO / 500 SUS	Solest 100
CPI Solest 120	Polyolester	120 ISO / 600 SUS	Solest 120
CPI Solest 150	Polyolester	150 ISO / 750 SUS	Solest 150
CPI Solest 170	Polyolester	170 ISO / 800 SUS	Solest 170
CPI Solest 220	Polyolester	220 ISO / 1000 SUS	Solest 220
CPI Solest 370	Polyolester	370 ISO / 1700 SUS	Solest 370
CPI CP 4214-150	Polyolester	150 ISO / 750 SUS	CP 4214-150
CPI CP 4214-320	Polyolester	320 ISO / 1500 SUS	CP 4214-320
Emkarate RL32H	Polyolester	32 ISO / 150 SUS	As Specified by OEM
Emkarate RL220+	Polyolester	220 ISO / 1000 SUS	As Specified by OEM
Emkarate RL32-3MAF	Polyolester	32 ISO / 150 SUS	NL PE 32
Emkarate RL46H	Polyolester	46 ISO / 200 SUS	Solest 46
Emkarate RL170H	Polyolester	170 ISO / 800 SUS	Solest 170
Emkarate RL68H	Polyolester	68 ISO / 300 SUS	As Specified by OEM
Frick #2A	Mineral Oil	300 SUS / 68 ISO	NL 300
Frick #5	Mineral Oil	150 SUS / 32 ISO	NL 150
Frick #6	Alkylbenzene	150 SUS / 32 ISO	NL AKB 150
Frick #7	Alkylbenzene	300 SUS / 68 ISO	NL AKB 300
Frick #13	Polyolester	68 ISO / 300 SUS	NL PE 68, Solest 68
Frick #3	Mineral Oil	300 SUS / 68 ISO	NL 300
Hitachi SR-30	Polyolester	320 ISO / 1500 SUS	CP 4214-320
Maneurop 160Z	Polyolester	32 ISO / 150 SUS	NL PE 32
Maneurop 160HZ	Polyolester	32 ISO / 150 SUS	NL PE 32
Maneurop 160P	Mineral Oil	150 SUS / 32 ISO	NL 150
Maneurop 160PZ	Polyolester	32 ISO / 150 SUS	NL PE 32
Maneurop 160SZ	Polyolester	32 ISO / 150 SUS	NL PE 32



OEM PART #	Lubricant Type	Viscosity	
Mobil EAL Arctic 46	Polyolester	46 ISO / 200 SUS	Solest 46
Mobil EAL Arctic 22 CC	Polyolester	22 ISO / 100 SUS	NL PE 32
Mobil EAL Arctic 32	Polyolester	32 ISO / 150 SUS	NL PE 32
Mobil Zerice S 32	Alkylbenzene	150 SUS / 32 ISO	NL AKB 150
Mobil EAL Arctic 68	Polyolester	68 ISO / 300 SUS	NL PE 68
Mobil EAL Arctic 100	Polyolester	100 ISO / 500 SUS	Solest 100
Mobil EAL Arctic 220	Polyolester	220 ISO / 1000 SUS	Solest 220
Mobil Zerice S 68	Alkylbenzene	300 SUS / 68 ISO	NL AKB 300
Mobil Zerice S 100	Alkylbenzene	500 SUS / 100 ISO	NL AKB 500E
National NL AKB 500E	Alkylbenzene	500 SUS / 100 ISO	NL AKB 500E
National NL PE 32	Polyolester	32 ISO / 150 SUS	NL PE 32
National NL PE 68	Polyolester	68 ISO / 300 SUS	NL PE 68
National NL 150	Mineral Oil	150 SUS / 32 ISO	NL 150
National NL 300	Mineral Oil	300 SUS / 68 ISO	NL 300
National NL 500	Mineral Oil	500 SUS / 100 ISO	NL 500
National NL AKB 150	Alkylbenzene	150 SUS / 32 ISO	NL AKB 150
National NL AKB 200R	Alkylbenzene	200 SUS / 46 ISO	NL AKB 200R
National NL AKB 300	Alkylbenzene	300 SUS / 68 ISO	NL AKB 300
National NL WF 32	Mineral Oil	150 SUS / 32 ISO	NL WF 32
National NL WF 68	Mineral Oil	300 SUS / 68 ISO	NL WF 68
Nu Calgon C3	Mineral Oil	150 SUS / 32 ISO	NL 150
Nu Calgon C4	Mineral Oil	300 SUS / 68 ISO	NL 300
Nu Calgon C5	Mineral Oil	500 SUS / 100 ISO	NL 500
Shell Clavus 32	Mineral Oil	150 SUS / 32 ISO	NL WF 32
Shell Clavus 68	Mineral Oil	150 SUS / 32 ISO	NL WF 68
Soltex RF 200A	Alkylbenzene	200 SUS / 46 ISO	NL AKB 200R
Soltex RF 150	Alkylbenzene	150 SUS / 32 ISO	NL AKB 150
Soltex RF 300	Alkylbenzene	300 SUS / 68 ISO	NL AKB 300
Suniso 3GS	Mineral Oil	150 SUS / 32 ISO	NL 150
Suniso 4GS	Mineral Oil	300 SUS / 68 ISO	NL 300
Suniso 5GS	Mineral Oil	500 SUS / 100 ISO	NL 500
Trane 0015	Mineral Oil	300 SUS / 68 ISO	NL 300
Trane 0027	Polyolester	32 ISO / 150 SUS	NL PE 32
Trane 0031	Mineral Oil	300 SUS / 68 ISO	NL 300
Trane 0042	Mineral Oil	150 SUS / 32 ISO	NL 150
Trane 0037	Polyolester	68 ISO / 300 SUS	NL PE 68
Trane 0043	Mineral Oil	150 SUS / 32 ISO	NL 150
Trane 0045	Mineral Oil	300 SUS / 68 ISO	NL 300
Trane 0046	Polyolester	68 ISO / 300 SUS	NL PE 68
Trane 0048	Polyolester	68 ISO / 300 SUS	NL PE 68
Trane 0075	Polyolester	68 ISO / 300 SUS	NL PE 68
Trane 0078	Polyolester	32 ISO / 150 SUS	NL PE 32



OEM PART #	Lubricant Type	Viscosity	
Trane 0086	Polyolester	100 ISO / 500 SUS	Solest 100
Trane 0152	Polyolester	46 ISO / 200 SUS	Solest 46
Trane 0080	Polyolester	32 ISO / 150 SUS	NL PE 32
York A	Mineral Oil	300 SUS / 68 ISO	NL 300
York C	Mineral Oil	300 SUS / 68 ISO	NL 300
York D	Mineral Oil	150 SUS / 32 ISO	NL 150
York E	Mineral Oil	500 SUS / 100 ISO	NL 500
York F	Mineral Oil	150 SUS / 32 ISO	NL 150
York G	Polyolester	320 ISO / 1500 SUS	CP 4214-320
York H	Polyolester	68 ISO / 300 SUS	Solest 68, NL PE 68
York J	Polyolester	46 ISO / 200 SUS	Solest 46
York K	Polyolester	32 ISO / 150 SUS	Solest LT32, NL PE 32
York L	Polyolester	120 ISO / 600 SUS	Solest 120
York O	Polyolester	32 ISO / 150 SUS	Solest LT32, NL PE 32
York P	Polyolester	150 ISO / 750 SUS	CP 4214-150
York S	Polyolester	100 ISO / 500 SUS	Solest 100
York T	Polyolester	32 ISO / 150 SUS	NL PE 32
York V	Polyolester	32 ISO / 150 SUS	NL PE 32
Zerol 150	Alkylbenzene	150 SUS / 32 ISO	NL AKB 150
Zerol 200TD	Alkylbenzene	200 SUS / 46 ISO	NL AKB 200R
Zerol 300	Alkylbenzene	300 SUS / 68 ISO	NL AKB 300
Zerol 500	Alkylbenzene	500 SUS / 100 ISO	NL AKB 500E



**Scan QR Code
or
Point your phone's
browser to
[www.refrigerants.com
/lubricants](http://www.refrigerants.com/lubricants)
and select
Cross Reference**



**Lubricant
Cross
Reference**

APP





GET IT NOW!



Mineral Lubricants



Quality Lubricant Products for the HVAC/R Industry

NL Naphthenic Mineral Oils (pale oils) are the traditional choice for lubrication in air conditioning and refrigeration compressors. They are used primarily in systems designed for CFCs (R-12, R-502) and HCFCs (R-22, retrofit blends).

NL Mineral Oils are made from the highest quality base stocks and provide outstanding performance and protection in compressors. Available in 150 SUS, 300 SUS and 500 SUS viscosities, these products can be used in most reciprocating, scroll, screw and many centrifugal compressors on the market today.

NL Mineral Oils perform well over a wide temperature range. They have very good chemical stability and provide very good protection and lubrication at higher compressor temperatures. In addition, they have low wax content and have chemical characteristics that promote a low pour point and good oil return to the compressor at low evaporator temperatures. Naphthenic Mineral Oils do a very good job of preventing system deposits compared to paraffinic (white) mineral oils.

Available Sizes	Part Numbers
1 Gallon	1501G 3001G 5001G
5 Gallon	1505G 3005G 5005G
55 Gallon	15055G 30055G 50055G

TYPICAL PROPERTIES

PROPERTY	Test Method	150	300	500
Viscosity, SUS @ 100 °F	ASTM D445	155	325	510
Flash Point, °F	ASTM D92	350	400	405
Pour Point, °F	ASTM D97	-50	-30	-15
Floc Point, °F	ASTM D86	-72	-56	-51
Color Gardner	ASTM D1500	<0.5	<0.5	<0.5
Typical water content, ppm	ASTM D1533	<25	<25	<25
Specific Gravity	ASTM D1250	.904	0.910	0.916



Alkylbenzene Lubricants



Quality Lubricant Products for the HVAC/R Industry

NL Alkylbenzene (AKB) synthetic refrigeration lubricants provide outstanding performance for extended drain intervals and better thermal stability compared to traditional mineral oil. They can be used in systems designed for CFCs (R-12, R-502) and HCFCs (R-22, retrofit blends).

NL Alkylbenzenes are made from the highest quality synthetic base stocks and provide outstanding performance and protection in compressors. These synthetic lubricants do not contain wax and can survive longer than mineral oils at high compressor discharge temperatures. Alkylbenzenes typically run cleaner in systems than mineral based oils. Available in 150 SUS, 200 SUS and 300 SUS viscosities, these products can be used in most reciprocating, rotary vane, and scroll compressors on the market today.

NL Alkylbenzenes are particularly well suited for use in retrofit projects. In some cases, equipment manufacturers suggest the replacement of some mineral oil with alkylbenzene when using HCFC-based retrofit blends. During HFC retrofit projects, using alkylbenzene for initial oil flushing helps remove mineral oil and contaminants in preparation for a final POE flush, thus saving money on POE.

NL AKB 200R meets the strict retrofit recommendations imposed by some equipment manufacturers, such as Copeland.

Available Sizes	Part Numbers
1 Gallon	150AKB1G 200AKB1G 300AKB1G
5 Gallon	150AKB5G 200AKB5G 300AKB5G
55 Gallon	150AKB55G 200AKB55G 300AKB55G

TYPICAL PROPERTIES

PROPERTY	Test Method	AKB150	AKB200R	AKB300
Viscosity, SUS @ 100 °F	ASTM D445	150	205	280
Color Gardner	ASTM D1500	1	<1	1
Flash Point, °F	ASTM D92	347	365	365
Pour Point, °F	ASTM D97	-49	-49	-49
Typical water content, ppm	ASTM D1533	<25	<25	<25
Refractive Index	—	1.4865	1.4857	1.4841



Polyolester Lubricants



Quality Lubricant Products for the HVAC/R Industry

NL Polyolester (POE) synthetic refrigeration lubricant is recommended for use with all HFC refrigerants such as R407A and R407C. It is also compatible with HCFC refrigerants and it can be used with confidence in systems containing R-22 or HCFC based blends.

NL POEs are made from the highest quality base stocks and provide outstanding performance in a wide variety of air conditioning and refrigeration compressors. Available in 32 cSt and 68 cSt viscosities, these products can be used in most reciprocating, scroll, screw and many centrifugal compressors on the market today.

NL POEs perform well over a wide temperature range. They provide maximum protection and lubrication at higher compressor temperatures. In addition, good refrigerant miscibility at low evaporator temperatures will help promote oil return to the compressor.

NL POEs are based on the most current industry standard formulations. These lubricants contain no extra antiwear additives that can leave deposits. They are compatible with existing mineral oil and alkylbenzene lubricants, making them excellent for retrofitting older systems to HFC refrigerants.

Available Sizes	Part Numbers
1 Pint	PE321P PE681P
1 Quart	PE321Q PE681Q
1 Gallon	PE321G PE681G

TYPICAL PROPERTIES

PROPERTY	Test Method	PE32	PE68
Viscosity, cSt @ 104°F	ASTM D445	32	68
Viscosity, cSt @ 212°F	ASTM D445	5.8	9.3
Flash Point, °F	ASTM D92	496.5	518
Pour Point, °F	ASTM D97	-51	-38.2
Total acid number, mgKOH/g	ASTM D664	<0.02	<0.02
Typical water content, ppm	ASTM D1744	<50	<50
Miscibility Temp, °F	IN HOUSE	-44	-15
Density, g/ml @ 68°F	ASTM D1298	0.977	0.980



Solest® Lubricants

Solest® products are high quality Polyolester Synthetic Lubricants designed for use with air conditioning and industrial refrigeration compressors. These new products extend the viscosity range of synthetic lubricants available from National Refrigerants, Inc. The **Solest® Lubricant** products are excellent choices for initial fill, service and retrofit applications.

Solest LT 32	Specifically designed for very low temperature applications; provides good miscibility with R-404A, eliminating the need to use two lubricants in a cascade system
Solest 46	Used in centrifugal, reciprocating and rotary vane compressors
Solest 68	Can be used in a wide variety of compressor units
Solest 100	Used primarily in scroll and screw compressors
Solest 120	Provides a good oil return in screw applications
Solest 150, 170 & 180	These lubricants are used mainly in Bitzer and Carlyle screw compressors
Solest 220	Mostly used in large screw type applications with R-134a
CP-4214-150 & CP4214-320	A complex ester lubricant that cannot be used with HFC refrigerants; provides good oil return in R-22 screw type applications
Solest 370	Used in screw type applications with HFC refrigerants
Alkylbenzene 500E	Alkylbenzene based lubricant; provides good miscibility with HCFC refrigerants and has the higher viscosity needed to work well with screw compressors

Solest® Product	Part #	Viscosity	Equivalent OEM Part #
Solest LT 32	SolestLT321G	32 ISO/150 SUS	York K, York O
Solest 46	Solest461G	46 ISO/200 SUS	York J, Trane 0152
Solest 68	Solest681G	68 ISO/300 SUS	York H, Trane 0037, Frick 13
Solest 100	Solest1001G	100 ISO/500 SUS	York S, Trane 0086
Solest 120	Solest1201G	120 ISO/600 SUS	York L
Solest 150	Solest1501G	150 ISO/700 SUS	
CP4214-150	CP4214-1505G	150 ISO/700 SUS	York P, BSE 150SH
Solest 170	Solest1701G	170 ISO/800 SUS	Bitzer BSE 170
Solest 180	Solest1801G	180 ISO/850 SUS	
Solest 220	Solest2201G	220 ISO/1000 SUS	Castrol SW220, BSE 220
CP 4214-320	CP4214-3201G	320 ISO/1500 SUS	York G, BSE 320SH
Solest 370	Solest3701G	370 ISO/1700 SUS	
AKB 500 E	AKB500E1G	100 ISO/500 SUS	BVA 100E, Zerol 500



Solest® Lubricants are available in the following sizes:

1 Gallon / 5 Gallon / 55 Gallon



Propylene Glycol

Contains DOWFROST™ heat transfer fluid

NC Inhibited Propylene Glycol heat transfer fluid contains DOWFROST™ blended to different concentrations. It contains a performance additive that prevents metal corrosion, lowers maintenance cost, and improves heat transfer. It also provides freeze and burst protection based on the type of application.

NC Inhibited Propylene Glycol has a low toxicity level, so it can be used in applications that have contact with food or beverage products such as immersion freezing and packaging carbonated beverages. It is also used for secondary cooling and heating applications, and for various defrosting and dehumidifying applications.



*Many different concentrations
With or without dye
1 Gallon / 5 Gallon / 55 Gallon*

	Part #	Concentration	Container Size
BLUE DYE	55PG35D	35%	55 gallon
	5PG40	40%	5 gallon
	55PG40	40%	55 gallon
	55PG45	45%	55 gallon
	1PG70	70%	1 gallon
	5PG70	70%	5 gallon
	55PG70	70%	55 gallon
NO DYE	55PG35	35%	55 gallon
	5PG96	96%	5 gallon
	55PG96	96%	55 gallon
FOOD GRADE	PROPYL55G	Uninhibited USP Food-Grade Kosher 99.9%	55 gallon

FOR FREEZE PROTECTION

TEMP	Volume %				
°F	PG35	PG40	PG45	PG70	PG96
20	49	43	38	25	18
10	80	70	62	40	29
0	99	86	77	49	36
-10			90	58	42
-20			98	63	46
-30				69	50
-40				74	54
-50				78	57
-60				82	60

FOR BURST PROTECTION

TEMP	Volume %				
°F	PG35	PG40	PG45	PG70	PG96
20	33	29	26	16	12
10	55	48	43	27	20
0	66	58	51	33	24
-10	77	67	60	38	28
-20	82	72	64	41	30
-30	91	79	70	45	33
-40	96	84	75	48	35
-50	96	84	75	48	35
-60	96	84	75	48	35

Based on the desired application temperature, the amount of Propylene Glycol can be calculated with the following formula:

$$\text{Volume of PG Required} = (\text{system volume}) * (\% \text{ of PG based on Table Value}) * 0.01$$

**Recommended Concentrations:**

Minimum: 25% propylene glycol. Less will reduce the inhibitor concentration below effective levels, and also promote the risk of bacterial contamination.

Maximum: 60% propylene glycol. More will increase the viscosity to the point where resistance to flow will become a problem for pumps. General freeze protection will not improve above 60%

Select a concentration that will have a target freezing point about 5°F below the minimum expected ambient temperature.

TYPICAL FREEZING AND BOILING POINTS, AND IDENTIFICATION DATA
FOR AQUEOUS SOLUTIONS OF PROPYLENE GLYCOL

FREEZING POINT					BOILING POINT			
°F	°C	WT % PROPYLENE GLYCOL	VOL % PROPYLENE GLYCOL	VOL % DOWFROST	°F @ 760MMHG BARR	°C @ 0.96	DEGREE BRIX	REFRACTIVE INDEX
32.0	0.0	0.0	0.0	0.0	212	100	0.0	1.3328
29.1	-1.6	5.0	4.8	5.0	212	100	4.8	1.3383
26.1	-3.3	10.0	9.6	10.0	212	100	8.4	1.3438
22.9	-5.1	15.0	15.5	15.1	212	100	12.9	1.3495
19.2	-7.1	20.0	19.4	20.3	213	101	15.4	1.3555
14.7	-9.6	25.0	24.4	25.5	214	101	19.0	1.3615
9.2	-12.7	30.0	29.4	30.7	216	102	22.0	1.3675
2.4	-16.4	35.0	34.4	36.0	217	103	26.1	1.3733
-6.0	-21.1	40.0	39.6	41.4	219	104	29.1	1.3790
-16.1	-26.7	45.0	44.7	46.7	220	104	31.8	1.3847
-28.3	-33.5	50.0	49.9	52.2	222	106	34.7	1.3903
-42.8	-41.6	55.0	55.0	57.5	223	106	38.0	1.3956
-59.9	-51.1	60.0	60.0	62.7	225	107	40.6	1.4008
<-60	<-52	65.0	65.0	68.0	227	108	42.1	1.4058
<-60	<-52	70.0	70.0	73.2	230	110	44.1	1.4104
<-60	<-52	75.0	75.0	78.4	237	114	46.1	1.4150
<-60	<-52	80.0	80.0	83.6	245	118	48.0	1.4193
<-60	<-52	85.0	85.0	88.9	257	125	50.0	1.4235
<-60	<-52	90.0	90.0	94.1	270	132	51.4	1.4275
<-60	<-52	95.0	95.0	99.3	310	154	52.8	1.4315

Operating Temperature Range: -50 °F to 250 °F

- -50 °F to 0 °F – increased viscosity may require stronger pumps
- 150 °F to 250 °F – closed system required to reduce oxidation of glycol and inhibitor

Use of make up water is not recommended — it may result in dilution of glycol concentration. Instead, a reservoir of the proper concentration solution should be used to feed make up volumes as needed.



Recommendations for Replacement of Entire Charge

- If the concentration changes below the desired range (becomes too dilute)
- If the pH drops below 7 (normal pH range is from 8 and 10). This indicates that the inhibitor has been used up.
- Dark color, oily layer, or strong smell, all of which indicate contamination of the glycol.

Storage of Unused Glycol

There are no limitations on the long-term storage of propylene glycol in the original drums or pails, as long as they are closed to the air. Steel storage tanks, however, may experience corrosion in the vapor space above the liquid since there is no contact with the inhibitor. Provisions should be taken to limit air/moisture exchange into vapor space of the tank.

VOLUME OF HEAT TRANSFER FLUID PER LENGTH OF PIPE (schedule 40 steel pipe)

NOMINAL PIPE SIZE (INCH)	WALL THICKNESS (INCHES)	INSIDE DIAMETER (INCHES)	USG PER 100 FT OF PIPE
1/4	0.088	0.364	0.541
3/8	0.091	0.493	.0992
1/2	0.109	0.622	1.579
3/4	0.113	0.824	2.770
1	0.113	1.049	4.490
1 1/4	0.14	1.380	7.770
1 1/2	0.145	1.610	10.576
2	0.154	2.067	17.433
2 1/2	0.203	2.469	24.873
3	0.216	3.068	38.406
3 1/2	0.226	3.548	51.363
4	0.237	4.026	66.135
5	0.258	5.047	103.933
6	0.280	6.065	150.089
8	0.322	7.981	259.897
10	0.365	10.020	409.659
12	0.406	11.938	581.501

This information was obtained from the "DowFrost Engineering and Operations Guide". For more technical information on Propylene Glycol please visit Dow's website at: www.dowfrost.com

The complete "DowFrost Engineering and Operations Guide" can be found under the Literature tab.



V

REGULATORY & LEGISLATIVE ISSUES

The following section is a compilation of EPA publications relating to the HVAC/R industry.

PG: 130-137 COMPLYING WITH SECTION 608 REQUIREMENTS

PG: 138-140 THE REFRIGERANT SALES RESTRICTION

PG: 141-142 LEAK REPAIR

PG: 143 CHANGING REFRIGERANT OIL

PG: 144-145 OVERLAP BETWEEN SECTION 608 AND SECTION 609

PG: 146-147 EPA HFC ALLOCATION AND PRE-CHARGED EQUIPMENT RULES

For further information on these publications, or any other regulatory questions, contact the

EPA Stratospheric Hot-line

at 1.800.296.1996 or visit the

EPA website: **www.epa.gov/ozone**



Complying with Section 608 Regulations

This section provides an overview of the refrigerant recycling requirements of Section 608 of the Clean Air Act of 1990, as amended (CAA), including final regulations published on May 14, 1993 (58 FR 28660), August 19, 1994 (59 FR 42950), November 9, 1994 (59 FR 55912), and July 24, 2003 (68 FR 43786). This section also describes the prohibition on intentional refrigerant venting that became effective on July 1, 1992.

- Overview
- Prohibition on Venting
- Regulatory Requirements
- Evacuation Requirements
- Exceptions to Evacuation Requirements
- Reclamation Requirement
- Refrigerant Recovery and Recycling Equipment Certification
- Refrigerant Leaks
- Technician Certification
- Refrigerant Sales Restrictions
- Certification by Owners of Refrigerant Recovery and Recycling Equipment
- Refrigerant Reclaimer Certification
- Safe Disposal Requirements
- Major Recordkeeping Requirements

OVERVIEW

Under Section 608 of the CAA, EPA has established regulations (40 CFR Part 82, Subpart F) that:

- Require service practices that maximize recovery and recycling of ozone-depleting substances (both chlorofluorocarbons (CFCs) and hydrochlorofluorocarbons (HCFCs) and their blends) during the servicing and disposal of air-conditioning and refrigeration equipment.
- Set certification requirements for refrigerant recycling and recover equipment, technicians, and refrigerant reclaimers.
- Restrict the sale of refrigerant to certified technicians.
- Require the repair of substantial leaks in air-conditioning and refrigeration equipment with a refrigerant charge greater than 50 pounds.
- Establish safe disposal requirement to ensure removal of refrigerants from goods that enter the waste stream with the charge intact (e.g., motor vehicle air conditioners, home refrigerators, and room air conditioners.)



THE PROHIBITION ON VENTING

Effective July 1, 1992, Section 608 of the Act prohibits individuals from intentionally venting ozone-depleting substances used as refrigerants (generally CFCs and HCFCs) into the atmosphere while maintaining, servicing, repairing, or disposing of air-conditioning or refrigeration equipment (appliances). Only four types of releases are permitted under the prohibition.

1. "De minimis" quantities of refrigerant released in the course of making good faith attempts to recapture and recycle or safely dispose of refrigerant.
2. Refrigerants emitted in the course of normal operation of air-conditioning and refrigeration equipment (as opposed to during the maintenance, servicing, repair or disposal of this equipment) such as from mechanical purging and leaks. However, EPA requires the repair of leaks above a certain size in large equipment. (see Refrigerant Leaks)
3. Releases of CFCs or HCFCs that are not used as refrigerants. For instance, mixtures of nitrogen and R-22 that are used as holding charges or as leak test gases may be released.
4. Small releases of refrigerant that result from purging hoses or from connecting or disconnecting hoses to charge or service appliances will not be considered violations of the prohibition on venting. However, recovery and recycling equipment manufactured after November 15, 1993, must be equipped with low-loss fittings.

REGULATORY REQUIREMENTS

Service Practice Requirements

1. Evacuation Requirements

Technicians are required to evacuate air-conditioning and refrigeration equipment to established vacuum levels when opening the equipment for maintenance, service, repair, or disposal. If the technician's recovery and/or recycling equipment was manufactured any time before November 15, 1993, the air-conditioning and refrigeration equipment must be evacuated to the levels described in the first column of Table 1. If the technician's recovery or recycling equipment was manufactured on or after November 15, 1993, the air-conditioning and refrigeration equipment must be evacuated to the levels described in the second column of Table 1, and the recovery or recycling equipment must have been certified by an EPA -approved equipment testing organization.

Technicians repairing small appliances, such as household refrigerators, window air conditioners, and water coolers, must recover:

- 80 percent of the refrigerant when
 - the technician uses recovery or recycling equipment manufactured before November 15, 1993, or
 - the compressor in the appliance is not operating; OR
- 90 percent of the refrigerant when
 - the technician uses recovery or recycling equipment manufactured after November 15, 1993, and
 - the compressor in the appliance is operating

In order to ensure that they are recovering the correct percentage of refrigerant, technicians must use the recovery equipment according to the directions of its manufacturer. Technicians may also satisfy recovery requirements by evacuating the small appliance to four inches of mercury vacuum.



Required Levels of Evacuation

REQUIRED LEVELS OF EVACUATION FOR APPLIANCES EXCEPT FOR SMALL APPLIANCES, MVACS, AND MVAC-LIKE APPLIANCES

Type of Appliance	Inches of Mercury Vacuum* using Equipment Manufactured:	
	Before Nov. 15, 1993	On or After Nov. 15, 1993
HCFC-22 appliance** normally containing less than 200 pounds of refrigerant	0	0
HCFC-22 appliance** normally containing 200 pounds or more of refrigerant	4	10
Other high-pressure appliance** normally containing less than 200 pounds of refrigerant (CFC-12, -500 -502, -114)	4	10
Other high-pressure appliance** normally containing 200 pounds or more of refrigerant (CFC-12, -500 -502, -114)	5	15
Very high pressure appliance (CFC-13-503)	0	0
Low pressure appliance (CFC-11, HCFC-123)	25	25 mm Hg absolute

* Relative to standard atmospheric pressure of 29.9" Hg

** Or isolated component of such an appliance

2. Exceptions to Evacuation Requirements

EPA has established limited exceptions to its evacuation requirements for 1) repairs to refrigeration and air-conditioning equipment and 2) repairs that are not major and that are not followed by an evacuation of the equipment to the environment.

If, due to leaks, evacuation to the levels in Table 1 is not attainable, or would substantially contaminate the refrigerant being recovered, the persons opening the appliance must:

- isolate leaking from non-leaking components wherever possible;
- evacuate non-leaking components to the levels in Table 1; and
- evacuate leaking components to the lowest level that can be attained without substantially contaminating the refrigerant. This level cannot exceed 0 psig.

If evacuation of the equipment to the environment is not to be performed when repairs are complete, and if the repair is not major, then the appliance must:

- be evacuated to at least 0 psig before it is opened if it is a high or very-high pressure appliance, or
- be pressurized to 0 psig before it is opened if it is a low-pressure appliance. Methods that require subsequent purging (e.g., nitrogen) cannot be used except with appliances containing R-113.



3. Reclamation Requirement

EPA has also established that refrigerant recovered and/or recycled can be returned to the same system or other systems owned by the same person without restriction. If refrigerant changes ownership, it must be reclaimed (i.e., cleaned to the AHRI 700-1193 Standard of purity) by an EPA certified refrigerant reclaimer.

REFRIGERANT RECOVERY AND RECYCLING EQUIPMENT CERTIFICATION

The Agency has established a certification program for refrigerant recovery and recycling equipment. EPA required that manufacturers or importers of refrigerant recovery and recycling equipment manufactured on or after November 15, 1993, have their equipment tested by an EPA-approved testing organization to ensure that it meets EPA requirements. Equipment intended for use with air-conditioning and refrigeration equipment must be tested under EPA requirements based upon the AHRI 740 test protocol (i.e., EPA Appendices B and B1 to 40 CFR 82 subpart F). Recycling and recovery equipment intended for use with small appliances must be tested under EPA Appendix C or alternatively under requirements based upon the AHRI 740 test protocol (i.e., Appendices B and B1 to 40 CFR 82 subpart F).

The Agency requires recovery efficiency standards that vary depending on the size and type of air-conditioning or refrigeration equipment being serviced. For recovery and recycling equipment intended for use with air-conditioning and refrigeration equipment besides small appliances, these standards are the same as those in the second column of Table 1. Recovery equipment intended for use with small appliances must be able to recover 90 percent of the refrigerant in the small appliance when the compressor is not operating.

EPA has approved both the Air-conditioning, Heating, and Refrigeration Institute (AHRI) and Underwriters Laboratories (UL) to certify recycling and recovery equipment. Certified equipment can be identified by a label reading: "This equipment has been certified by ARI/UL to meet EPA's minimum requirements for recycling and/or recovery equipment intended for use with (appropriate category of appliance — e.g., small appliances, HCFC appliances containing less than 200 pounds of refrigerant, all high-pressure appliances, etc.)." Lists of certified equipment may be obtained by contacting AHRI at (703)524-8800 and UL at (708)272-8800, ext. 42371.

REFRIGERANT LEAKS

Owners or operators of refrigeration and air-conditioning equipment with refrigerant charges greater than 50 pounds are required to repair leaks within 30 days when those leaks result in the loss of more than a certain percentage of the equipment's refrigerant charge over a year. For the commercial (e.g. grocery stores and warehouses) and industrial process refrigeration sectors, leaks must be repaired within 30 days when the equipment leaks at a rate that would release 35 percent or more of the charge over a year. For all other sectors, including comfort cooling (such as building chillers), leaks must be repaired when the appliance leaks at a rate that would release 15 percent or more of the charge over a year.

The trigger for repair requirements is the current leak rate projected over a consecutive 12-month period rather than the total quantity of refrigerant lost. For instance, owners or operators of a commercial refrigeration system containing 100 pounds of charge must repair leaks if they find that the system



has lost 10 pounds of charge over the past month; although 10 pounds represents only 10 percent of the system charge in this case, a leak rate of 10 pounds per month would result in the release of over 100 percent of the charge over the year. To track leak rates, owners or operators of air-conditioning and refrigeration equipment with more than 50 pounds of charge must keep records of the quantity of refrigerant added to their equipment during servicing and maintenance procedures. Owners or operators are required to repair leaks within 30 days of discovery. This requirement is waived if, within 30 days of discovery, owners develop a one-year retrofit or retirement plan for the leaking equipment. Owners of industrial process refrigeration equipment may qualify for additional time under certain circumstances. For example, if an industrial process shutdown is required to repair a leak, owners have 120 days to repair the leak. Owners of industrial process refrigeration equipment should reference the Compliance Assistance Guidance Document for Industrial Process Refrigeration Leak Repair for additional information concerning time extensions and pertinent recordkeeping and reporting requirements.

The leak repair regulations do not apply to refrigeration and air-conditioning equipment with refrigerant charge sizes less than 50 pounds (such as residential split air-conditioning systems). However, smaller equipment is not exempt from the refrigerant venting prohibition. EPA regulations prohibit the intentional release of all refrigerants during the maintenance, service, repair, or disposal of air-conditioning and refrigeration equipment.

TECHNICIAN CERTIFICATION

For additional information see *Leak Repair* on page 141.

EPA has established a technician certification program for persons (“technicians”) who perform maintenance, service, repair, or disposal that could be reasonably expected to release refrigerants into the atmosphere. The definition of “technician” specifically includes and excludes certain activities as follows:

Included:

- attaching and detaching hoses and gauges to and from the appliance to measure pressure within the appliance;
- adding refrigerant to (for example “topping off”) or removing refrigerant from the appliance.
- any other activity that violates the integrity of the MVAC-like appliances, and small appliances.

In addition, apprentices are exempt from certification requirements provided the apprentice is closely and continually supervised by a certified technician.

The Agency has developed four types of certification:

1. For servicing small appliances (Type I)
2. For servicing or disposing of high or very high-pressure appliances, except small appliances and MVACs (Type II)
3. For servicing or disposing of low-pressure appliances (Type III).
4. For servicing all types of equipment (Universal).

Technicians are required to pass an EPA-approved test given by an EPA-approved certifying organization to become certified under the mandatory program. Section 608 Technician Certification credentials do not expire.



TECHNICIAN CERTIFICATION (SECTION 608):

Steps for Replacing a Lost Card

Step 1: Is your testing organization that issued your certification still in business? Check the list of certifying organizations that are still operating.

Yes, my organization is still operating.

Go to that organization and get a replacement card. They are required to maintain records of people issued cards.

No. — Go to Step 2.

Step 2: Do you have documentation from your original testing organization that demonstrates successful completion of the Section 608 Technician Certification exam? Do you or a current or former employer have a copy of your lost card?

Yes. I have documentation from my original testing organization.

Go to the list of certifying organizations that will replace cards. Send a copy of your documentation to one of the organizations (who have volunteered to make cards for people who can't get them from their certifying organization) on the list. They will issue you a new card and they will maintain a record of your certification.

No. — Go to Step 3.

Step 3: Is the record of your certification in our centralized files which were compiled from data submitted by certifying organizations that have gone out of business? Go to the list of certifying organizations that have closed.

Yes, the record of my certification is in the data submitted by companies that have gone out of business.

Download and complete the Assistance with Obtaining a Replacement card form (PDF, 1pp., 14K, about PDF). After completing the form mail or fax it to the Section 608 Technician Certification Program Manager. Once it is received EPA will contact you with information on how to obtain a replacement card.

No. — Go to Step 4.

Step 4: If you cannot answer "yes" to any of the steps above, EPA will not issue a replacement card. You will need to retake the Section certification test. Please go to the Section 608 Technician Certification Programs page to find testing organizations which meet your needs.

REFRIGERANT SALES RESTRICTIONS*

The sale of ozone-depleting refrigerant (such as R-11, R-12, and R-22) in any size container has been restricted to technicians certified either under the program described in Technician Certification above or under EPA's motor vehicle air conditioning regulations. The sales restriction covers ozone-depleting refrigerant contained in bulk containers, such as cans, cylinders, or drums.

The restriction excludes refrigerant contained in refrigerators or air conditioners with fully assembled refrigerant circuits (such as household refrigerators, window air conditioners, and packaged air conditioners), and HFC refrigerants (such as R-134a and R-410A).



Under Section 609 of the clean Air Act, sales of CFC-12 in containers smaller than 20 pounds are restricted solely to technicians certified under EPA's motor vehicle air-conditioning regulations (ie., Section 609 certified technicians). Technicians certified under EPA's stationary refrigeration and air-conditioning equipment (i.e., section 608 certified technicians) may buy containers of CFC-12 larger than 20 pounds.

Section 609 technicians are only allowed to purchase refrigerants that are suitable for use in motor vehicle air-conditioners. Effective September 22, 2003, EPA has restricted the sale of ozone-depleting refrigerants, approved for use in stationary refrigeration and air-conditioning equipment, to Section 608 certified technicians. Therefore, the sale of ozone-depleting refrigerants (such as HCFC-22) that are approved for use in stationary equipment but not for use in motor vehicle air-conditioners is restricted to Section 608 certified technicians. **For additional information see *The Refrigerant Sales Restriction* on page 138.**

** Additional restrictions apply in California.*

CERTIFICATION BY OWNERS OF REFRIGERANT RECOVERY AND RECYCLING EQUIPMENT

EPA requires that persons servicing, disposing, or recycling air-conditioning and refrigeration equipment certify to the appropriate EPA Regional Office that they have acquired (built, bought, or leased) refrigerant recovery or recycling equipment and that they are complying with the applicable requirements of this rule. This certification must be signed by the owner of the owner of the equipment or another responsible officer and sent to the appropriate EPA Regional Office. Although owners of recycling and recovery equipment are required to list the number of trucks based at their shops, they do not need to have a piece of recycling or recovery equipment for every truck. Owners do have to send in a new form each time they add recycling or recovery equipment to their inventory.

REFRIGERANT RECLAIMER CERTIFICATION

Refrigerant reclaimers are companies that reprocess used refrigerant back to virgin specifications. EPA restricts the resale of used refrigerant to a new owner, unless it has been reclaimed by an EPA certified refrigerant reclaimer. Reclaimers are required to return refrigerant to the purity level specified in AHRI Standard 700 (an industry-set purity standard) and to verify this purity using the laboratory protocol set forth in the same standard. In order to be recognized by EPA, refrigerant reclaimers must certify to the Section 608 Recycling Program Manager at EPA headquarters that they are complying with these requirements and that the information given is true and correct. Certification must also include the name and address of the reclaimer and a list of equipment used to process and to analyze the refrigerant.

SAFE DISPOSAL REQUIREMENTS

Refrigeration and air-conditioning equipment that is typically dismantled on-site before disposal (e.g., retail food refrigeration, central residential air conditioning, chillers, and industrial process refrigeration) has to have the refrigerant recovered in accordance with EPA's requirements for servicing prior to their disposal. However, equipment that typically enters the waste stream with the charge intact, (e.g. motor vehicle air conditioners, household refrigerators and freezers, and room air conditioners) are subject to special safe disposal requirements.



Under these requirements, the final person in the disposal chain (e.g., a scrap metal recycler or landfill owner) is responsible for ensuring that refrigerant is recovered from equipment before the final disposal of the equipment. If the final person in the disposal chain accepts appliances that no longer hold a refrigerant charge, that person is responsible for maintaining a signed statement from whom the appliance/s is being accepted. The signed statement must include the name and address of the person who recovered the refrigerant, and the date that the refrigerant was recovered, or a copy of a contract stating that the refrigerant will be removed prior to delivery. EPA does not mandate a sticker as a form of verification that the refrigerant has been removed prior to disposal of the appliance. Such stickers do not relieve the final disposer of their responsibility to recover any remaining refrigerant in the appliance, unless the sticker consists of a signed statement that includes the name and address of the person who recovered the refrigerant, and the date that the refrigerant was recovered.

Technician certification is not required for individuals removing refrigerant from small appliances, motor vehicle air conditioners, and motor vehicle-like air conditioners, when preparing them for disposal. However, the equipment used to recover refrigerant from appliances prior to their final disposal must meet the same performance standards as refrigerant recovery equipment used prior to servicing. Persons involved in the final disposal of appliances must certify to their EPA Regional Office that they have obtained and are properly using EPA certified refrigerant recovery equipment.

MAJOR RECORDKEEPING REQUIREMENTS

- | | |
|----------------------------|--|
| Technicians | servicing appliances that contain 50 or more pounds of refrigerant must provide the owner with an invoice that indicates the amount of refrigerant added to the appliance. Technicians must also keep a copy of their proof of certification at their place of business. |
| Owners or Operators | of appliances that contain 50 or more pounds of refrigerant must keep servicing records documenting the date and type of service, as well as the quantity of refrigerant added. |
| Wholesalers | who sell CFC and HCFC refrigerants must retain invoices that indicate the name of the purchases, the date of sale, and the quantity of refrigerant purchased. |
| Reclaimers | must maintain records of the names and addresses of persons sending them material for reclamation and the quantity of material sent to them for reclamation. This information must be maintained on a transactional basis. Within 30 days of the end of the calendar year, reclaimers must report to EPA the total quantity of material sent to them that year for reclamation, the mass of refrigerant reclaimed that year, and the mass of waste products generated that year. |



The Refrigerant Sales Restriction

The following questions and answers provide information about the restriction on sales of refrigerant to Section 608 or 609 certified technicians. A table summarizing this sales restriction is found here.

What does the sales restriction cover?

This sales restriction covers all CFC and HCFC refrigerants contained in bulk containers (such as cylinders, cans or drums). Refrigerant blends containing HCFCs (such as FRIGC FR-12, Free Zone, Hot Shot® or R-414B, GHG-X4 or R-414A, Freeze 12) are also covered under this sales restriction.

This sales restriction does not cover refrigeration and air-conditioning equipment or components containing an ozone-depleting refrigerant (such as components of residential split systems containing HCFC-22, also called R-22). Nor does the restriction cover the retail sale of air-conditioning and refrigeration appliances containing CFC or HCFC refrigerants (such as window air conditioners).

However, as of January 1, 2010, EPA banned the import and production of air-conditioning and refrigeration appliances and appliance components that are pre-charged with R-22. More information on EPA's rule banning the sale of pre-charged appliances and appliance components is found here.

EPA has previously banned the sale and distribution of refrigeration and air-conditioning appliances containing CFCs (such as R-12), under the Nonessential Products Ban.

What type of certification is required to purchase refrigerant?

The following people can buy any type of ozone-depleting refrigerant under this sales restriction (for instance, R-11, R-12, R-123, R-22), except for "small cans" containing less than 20 pounds of R-12:

- Technicians certified to service stationary refrigeration and air-conditioning equipment by a Section 608 EPA-certified testing organization; and
- Employers of a Section 608 certified technician (or the employer's authorized representative) if the employer provides the wholesaler with written evidence that he or she employs at least one properly certified technician.

The following people can buy refrigerant found acceptable for use in a motor vehicle air conditioner (MVAC), including "small cans" containing less than 20 pounds of R-12:

- Technicians certified to service motor vehicle air-conditioners by a Section 609 EPA-certified testing organization.

Can Section 609 certified technicians purchase R-22?

Effective, September 22, 2003, EPA has limited the sale of ozone-depleting refrigerants intended for use with stationary refrigeration and air-conditioning equipment to section 608 technicians. Therefore, section 609 technicians cannot purchase R-22, regardless of container size.

Note, that for purposes of maintenance, repair, service, or disposal, that buses using R-22 are not defined as MVACs; therefore, Section 608 certification (Type II or Universal) is required to service buses using R-22.

**Does the sales restriction apply to HFC refrigerants?**

This sales restriction only applies to refrigerants consisting of an ozone-depleting substance. Therefore, HFC refrigerants such as R-134a, and HFC refrigerant blends that do not contain an ozone-depleting substance, such as R-404A and R-410A, are not currently covered under this sales restriction.

Refrigerant blends that consist of an HFC and an ozone-depleting substance (such as, FRIGC FR-12, Free Zone, Hot Shot® or R-414B, GHG-X4 or R-414A, Freeze 12) are captured under this sales restriction. Section 608 or 609 technician certification is required to purchase these refrigerants.

Is it legal to intentionally release refrigerants that are not captured under the sales restriction?

It is illegal to intentionally release any refrigerant during the maintenance, service, repair or disposal of refrigeration and air-conditioning equipment, unless EPA determines that such a release does not pose a threat to the environment. It is illegal to intentionally vent all CFC, HCFC, and HFC refrigerants including, but not limited to, R-12, R-22, R-134a, R-404A, and R-410A.

What precautions must wholesalers take to ensure that persons who claim that they are purchasing refrigerant only for resale to certified technicians are actually doing so?

Wholesalers are legally responsible for ensuring that people who purchase refrigerant from them fit into one of the categories of people who can purchase refrigerant under the sales restriction (see the second question and answer above). Although the regulation does not specify precautions that wholesalers must take to verify the intent of individuals purchasing refrigerant for resale, EPA recommends that wholesalers who sell refrigerant for resale obtain at least a signed statement from the purchaser. This statement would state that the purchaser is purchasing the refrigerant only for eventual resale to certified technicians.

I understand that EPA recommends that wholesalers keep a list of persons (either by name or job title) who are authorized to pick up refrigerant for contractors who employ certified technicians. What if a contractor sends someone, such as a family member, to pick up refrigerant who is not on the list? What if a contractor wishes to have refrigerant delivered to his place of business when no employees or other authorized persons are present?

Under the regulations, wholesalers “may sell refrigerant to the purchaser or his authorized representative” if the purchaser provides evidence that he employs at least one certified technician. It is the wholesaler’s responsibility to determine whether persons who claim to represent a refrigerant purchaser are indeed authorized representatives; EPA recommends, but does not require, that wholesalers keep lists of authorized representatives to help with this determination. Thus, if a wholesaler knows that a certain person is an authorized representative of a purchaser, then the wholesaler may sell that person refrigerant as the representative, even if the person does not appear on the list of representatives.

Similarly, if a wholesaler knows that refrigerant delivered to the location of a purchaser when no one is present will ultimately be received by the purchaser or his authorized representative, then the wholesaler may deliver the refrigerant without obtaining the signature of an authorized representative.



Do wholesalers have to record the quantity of refrigerant sold in a pre-charged part?



Under the regulations, any persons who sell CFC or HCFC refrigerants must retain invoices that indicate the name of the purchaser, the date of sale, and the quantity of refrigerant purchased. This applies to refrigerants contained in pre-charged parts as well as refrigerants contained in cylinders or drums. However, EPA recognizes that while the quantity of refrigerant contained in a pre-charged part may be standardized by the make and model of the part, this quantity may not be immediately obvious to the wholesaler. Therefore, rather than attempt to estimate the quantity of refrigerant in a pre-charged part, wholesalers may simply record the identity of the pre-charged part (e.g., make, model, and number) along with the purchaser and date of sale. EPA believes that most invoices already contain this information.

Does the sales restriction also apply to internet sales?

Yes, for refrigerant sales EPA considers persons selling via internet sites, auctions, classified ads, and other means as wholesalers who must comply with the recordkeeping requirements for sales of ozone-depleting refrigerant.



Leak Repair

This page is a brief overview of the leak repair requirements for appliances containing class I or class II refrigerants (e.g. CFCs, HCFCs, or blends). Many other aspects of the requirements, particularly information on recordkeeping and reporting, are discussed in the general section 608 rule summary. The U.S. Environmental Protection Agency (EPA) and the Chemical Manufacturer’s Association (CMA) have developed a guidance document titled *Compliance Guidance For Industrial Process Refrigeration Leak Repair Regulations Under Section 608 of the Clean Air Act* that provides far greater detail than this overview. The guidance document is intended for those persons who are responsible for complying with the requirements. The guidance should not be used to replace the actual regulations published in the Federal Register on August 8, 1995 (60 FR 40420); however, it can act as a supplement to explain the requirements. Reliance on this fact sheet alone will likely not result in compliance.

Go to the EPA website to download the *Self-Audit Checklist For Industrial Process Refrigeration Leak Repair Regulations Under Section 608 of the Clean Air Act*.

www.epa.gov/ozone/title6/608/compguid/SelfAuditChecklist.pdf (28 pp, 68 kb)

Introduction

The leak repair requirements, promulgated under Section 608 of the Clean Air Act, require that when an owner or operator of an appliance that normally contains a refrigerant charge of more than 50 pounds discovers that refrigerant is leaking at a rate that would exceed the applicable trigger rate during a 12-month period, the owner or operator must take corrective action.

Trigger Rates

For all appliances that have a refrigerant charge of more than 50 pounds, the following leak rates for a 12-month period are applicable:

APPLIANCE TYPE	TRIGGER LEAK RATE
Commercial refrigeration	35%
Industrial process refrigeration	35%
Comfort cooling	15%
All other appliances	15%

In general, owners or operators must either repair leaks within thirty days from the date the leak was discovered, or develop a dated retrofit/retirement plan within thirty days and complete actions under that plan within one year from the plan’s date. However, for industrial process refrigeration equipment and some federally-owned chillers, additional time may be available.

Industrial process refrigeration is defined as complex customized appliances used in the chemical, pharmaceutical, petrochemical, and manufacturing industries. These appliances are directly linked to the industrial process. This sector also includes industrial ice machines, appliances used directly in the generation of electricity, and ice rinks. If at least 50 percent of an appliance’s capacity is used in an industrial process refrigeration application, the appliance is considered industrial process refrigeration equipment and the trigger rate is 35 percent.



Industrial process refrigeration equipment and federally-owned chillers must conduct initial and follow-up verification tests at the conclusion of any repair efforts. These tests are essential to ensure that the repairs have been successful. In cases where an industrial process shutdown is required, a repair period of 120 days is substituted for the normal 30-day repair period. Any appliance that requires additional time may be subject to recordkeeping/reporting requirements.

When Additional Time is Necessary

Additional time is permitted for conducting leak repairs where the necessary repair parts are unavailable or if other applicable federal, state, or local regulations make a repair within 30/120 days impossible. If owners or operators choose to retrofit or retire appliances, a retrofit or retirement plan must be developed within 30 days of detecting a leak rate that exceeds the trigger rates. A copy of the plan must be kept on site and the original plan must be made available to EPA upon request. Activities under the plan must be completed within 12 months (from the date of the plan). If a request is made within 6 months from the expiration of the initial 30-day period, additional time beyond the 12-month period is available for owners or operators of industrial process refrigeration equipment and federally-owned chillers in the following cases: EPA will permit additional time to the extent reasonably necessary where a delay is caused by the requirements of other applicable federal, state, or local regulations; or where a suitable replacement refrigerant, in accordance with the regulations promulgated under Section 612, is not available; and EPA will permit one additional 12-month period where an appliance is custom-built and the supplier of the appliance or a critical component has quoted a delivery time of more than 30 weeks from when the order was placed, (assuming the order was placed in a timely manner). In some cases, EPA may provide additional time beyond this extra year where a request is made by the end of the 9th month of the extra year.

Relief from Retrofit/Retirement

The owners or operators of industrial process refrigeration equipment or federally-owned chillers may be relieved from the retrofit or repair requirements if:

- second efforts to repair the same leaks that were subject to the first repair efforts are successful; or
- within 180 days of the failed follow-up verification test, the owners or operators determine the leak rate is below 35 percent. In this case, the owners or operators must notify EPA as to how this determination will be made, and must submit the information within 30 days of the failed verification test.

System Mothballing

For all appliances subject to the leak repair requirements, the timelines may be suspended if the appliance has undergone system mothballing. System mothballing means the intentional shutting down of a refrigeration appliance undertaken for an extended period of time where the refrigerant has been evacuated from the appliance or the affected isolated section of the appliance to at least atmospheric pressure. However, the timelines pick up again as soon as the system is brought back on-line.



Changing Refrigerant Oil

The requirements of Section 608 of the Clean Air Act Amendments of 1990 (the Act) and the implementing regulations cover refrigerant contained with oil. The oil in a refrigeration appliance may contain large amounts of dissolved refrigerant. EPA requires a reduction in the pressure prior to an oil change to ensure that the bulk of the refrigerant contained in the oil is recovered. Pressure must be reduced to a maximum of 5 psig. This reduction in pressure will greatly reduce refrigerant emissions while permitting a slight positive pressure to force the oil from the compressor.

There are two acceptable procedures for recovery of refrigerant contained in oil:

- Evacuate (or pressurize) the refrigeration appliance, or isolated portion, to a pressure no greater than 5 psig and then remove the oil; or
- Drain the oil into a system receiver to be evacuated (or pressurized) to a pressure no greater than 5 psig.

These procedures minimize the loss of refrigerant from the oil and the interior of the refrigeration appliance while the oil is drained. It is a violation to change oil at higher than 5 psig.

For further information concerning stratospheric ozone, copies of regulations or fact sheets, please call the **Stratospheric Ozone Information Hotline** at 1 (800) 296-1996.

Questions concerning the proper disposal of oil should be forwarded to the **RCRA Hotline** at (800) 424-9346 or **TDD** at (800) 553-7672.



Overlap between Section 608 and Section 609

Section 608 of the Clean Air Act Amendments of 1990 directs EPA to establish requirements to prevent the release of ozone-depleting substances during the servicing, repair, or disposal of appliances and industrial process refrigeration. Section 609 of the Act establishes standards specifically for the service of motor vehicle air conditioners (MVACs). MVACs are included in the definition of appliances set forth in section 608; however, since their service and repair are regulated under section 609, they are not subject to the servicing requirements under section 608. Procedures involving MVACs that are not covered by section 609, such as the disposal of MVACs and the purchase of refrigerant for use in MVACs, are covered by section 608. Below is information concerning specific areas where the overlap between these two sets of regulations may require additional clarification.

Technician Certification

Both regulations require that technicians become certified. Technicians who repair or service MVACs must be trained and certified by an EPA-approved section 609 program. These programs are specifically designed to cover MVAC recycling equipment in accordance with Society of Automotive Engineers (SAE) standards and section 609 regulatory requirements. After completing a required training program, MVAC technicians must pass a test to become certified. These tests are different from the section 608 certification tests .

Under section 608, EPA has established four types of certification for technicians who service and repair appliances other than MVACs. These technicians must be certified by passing a test in the appropriate area. All training and review classes for section 608 are voluntary; only passing the test is mandatory. The four categories of certification are:

- Type I = small appliances
- Type II = high-pressure appliances, except small appliances and MVACs
- Type III = low-pressure appliances
- Type IV (Universal) = all appliances except MVACs

In addition, people who service or repair MVAC-like appliances (e.g., farm equipment and other off-road vehicles) can choose to be certified under either the section 609 program or the section 608 Type II program. Due to similarities between MVACs and MVAC-like appliances, EPA recommends that technicians servicing MVAC-like appliances consider certification under section 609. Note that while buses using CFC-12 are MVACs, buses using HCFC-22 are not MVACs or MVAC-like appliances, but rather are high-pressure equipment covered under Type II of the section 608 test.

Sales Restriction

Under EPA regulations, only certified technicians may purchase refrigerants consisting whole or in part of CFC or HCFC refrigerants.

Section 608 technician certification is required in order to purchase CFC or HCFC containing refrigerants, with the exception of small containers (less than 20 lbs.) of CFC-12 or EPA-approved substitutes for MVACs containing an ozone-depleting substance (for example, Autofrost, Chill-it, HotShot, FR-12, Freeze 12).



Section 609 technician certification is required in order to purchase CFC-12 or EPA-approved substitutes for MVACs containing an ozone-depleting substance (for example, Autofrost, Chill-it, HotShot, FR-12, Freeze 12). Section 609 technicians cannot purchase HCFC-22 in any size container.

Recordkeeping

Section 608 requires that all persons who sell CFC and HCFC refrigerants, and blends thereof, retain invoices that indicate the name of the purchaser, the date of the sale, and the quantity of the refrigerant purchased. These requirements are for all sales affected by section 608.

However, since the sale of small containers of ozone-depleting MVAC refrigerants is restricted to section 609 technicians, these recordkeeping requirements do not apply to the sale of small containers of these refrigerants.

Therefore, while records must be maintained for the sale of all other refrigerants in any size container, and for the sale of ozone depleting MVAC refrigerants in containers of 20 pounds or more, it is not necessary to maintain records for the sale of small containers of ozone-depleting MVAC refrigerants when they are sold to persons servicing MVACs. For more information about recordkeeping, see the fact sheet Recordkeeping Requirements for Refrigerant Retailers



EPA HCFC Allocation and Precharged Equipment Rules

1) Allocation Rule: Adjustments to the Allowance System for Controlling HCFC Production, Import & Export allocates the production and import of HCFCs including R-22, R-142b, R-123 and R-124 for 2010 through 2014.

ALLOCATION RULE

EPA is allocating 80% of the estimated quantity of R-22 needed for after-market servicing in 2010 and will decrease the allocation each year so that the supply of R-22 will be less than the estimated demand. EPA will issue allocations for 2015-2019 at a later date based on projected servicing demand for those years.

Virgin R-123 and R-124 are allowed in newly manufactured appliances until January 1, 2020.

EPA Final Allocation Rule for R-22 supply through 2020 (millions of pounds)

2012	2013	2014	2015	2016	2017	2018	2019	2020
55.4 M	62.7 M	51.0 M	22.0 M	17.6 M	13.2 M	8.8 M	4.4 M	0

2) Precharged Equipment Rule: Ban of the Sale or Distribution of Precharged Equipment establishes regulations related to the sale or distribution or offer for sale or distribution in interstate commerce of air conditioning and refrigeration appliances containing R-22, R-142b and blends containing these refrigerants beginning January 1, 2010.

EPA DEFINITION OF APPLIANCE, COMPONENT AND MANUFACTURED:

- Appliance: Any device which contains and uses a refrigerant and which is used for household or commercial purposes, including air conditioners, refrigerators, chillers and freezers.
- Component: Any portion of the refrigerant circuitry that is necessary for the appliance to function in its intended purpose (examples: condenser, evaporator, compressor, TXV, line set, coil)
- Manufactured: The date of manufacture is when the appliance meets the following four criteria:
 - 1) Refrigerant circuit is complete
 - 2) Appliance is charged with refrigerant
 - 3) Appliance can function
 - 4) Appliance is ready for use for its intended purpose



HCFC Rules

PRECHARGED EQUIPMENT RULE

The Precharged Equipment Rule prohibits the precharging of all air conditioning and refrigeration appliances and components by OEMs beginning January 1, 2010.

The prohibition

- » Does not apply to precharged appliances and components that were manufactured prior to January 1, 2010
- » Does not prohibit the sale or distribution of pre-2010 inventory
- » Allows the sale and distribution of uncharged appliances and components
- » Allows use of reclaimed R-22 to field charge appliances manufactured after January 1, 2010
- » Allows uncharged components to be charged with virgin or reclaimed refrigerant if used for service only

Precharged Appliances & Components manufactured before January 1, 2010

- » No restriction on sale or distribution
- » Precharged components can only be used to service existing appliances
- » Virgin or reclaimed refrigerant can be used to service existing appliances

Appliances & Components manufactured after January 1, 2010

- » Appliances cannot be initially charged with virgin refrigerant, reclaimed refrigerant is okay
- » Components can be charged with virgin refrigerant if being used for service of existing appliance; otherwise, charge only with reclaimed refrigerant

Important Exceptions

- 1) Virgin R-22 may be used for the on-site manufacture (i.e. installation) of appliances for a specific project if the components being used on that project were manufactured before January 1, 2010 and if a building permit or contract was issued and dated prior to January 1, 2010. Projects that qualify for this exception must be completed by December 31, 2011.
- 2) Thermostatic expansion valve (TXV) manufacturers can use R-22 manufactured before January 1, 2010 to produce precharged TXVs until January 1, 2015.

